

MOTORES TUBULARES

GLB

TUBULAR MOTORS / MOTEURS TUBULAIRES

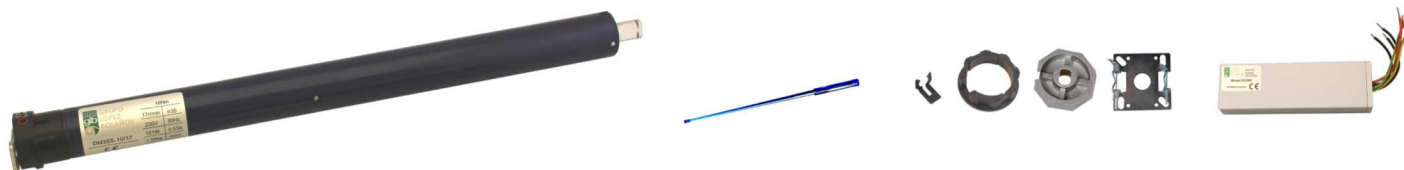

INFORMACIÓN TÉCNICA <i>TECHNICAL INFORMATION / INFORMATION TECHNIQUE</i>	DM35S 10/17						
Alimentación <i>Power supply / Tension nominal-Fréquence</i>	230V / 50Hz						
Potencia <i>Rated power / Puissance nominale</i>	121 W						
Intensidad <i>Rated current / Courant nominal</i>	0.53 A						
Par motor <i>Rated torque / Couple nominal</i>	10 Nm						
Revoluciones <i>Rated speed / Vitesse nominale</i>	17 rpm						
Número máximo de vueltas de recorrido <i>Max number of turns / Nombre máximo de tours de voyage</i>	30						
Tiempo de funcionamiento continuo <i>Running time / Temps de travail continu</i>	4 min.						
Protección <i>Degree of protection / Degré de protection</i>	IP 44						
Medidas <i>Dimensions / Dimensions</i>	<table border="1"> <tr> <td data-bbox="1065 1581 1127 1615">L1:</td> <td data-bbox="1345 1559 1424 1592">457</td> </tr> <tr> <td data-bbox="1065 1659 1127 1693">L2:</td> <td data-bbox="1345 1648 1424 1682">444</td> </tr> <tr> <td data-bbox="1065 1749 1093 1783">Ø:</td> <td data-bbox="1345 1749 1424 1783">35</td> </tr> </table>	L1:	457	L2:	444	Ø:	35
L1:	457						
L2:	444						
Ø:	35						

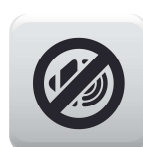
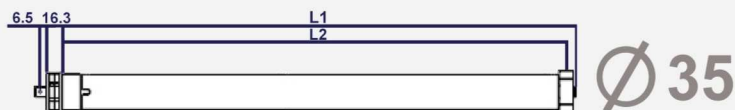

MOTORES TUBULARES

GLB

TUBULAR MOTORS / MOTEURS TUBULAIRES

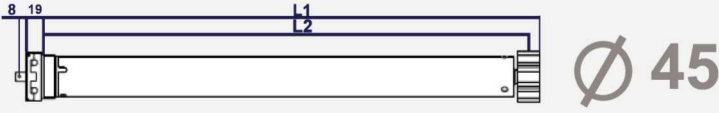

INFORMACIÓN TÉCNICA <i>TECHNICAL INFORMATION / INFORMATION TECHNIQUE</i>	DM45S 10/15
Alimentación <i>Power supply / Tension nominal-Fréquence</i>	230V / 50Hz
Potencia <i>Rated power / Puissance nominale</i>	112W
Intensidad <i>Rated current / Courant nominal</i>	0.49 A
Par motor <i>Rated torque / Couple nominal</i>	10 Nm
Revoluciones <i>Rated speed / Vitesse nominale</i>	15 rpm
Número máximo de vueltas de recorrido <i>Max number of turns / Nombre maximum de tours de voyage</i>	22
Tiempo de funcionamiento continuo <i>Running time / Temps de travail continu</i>	4 min.
Protección <i>Degree of protection / Degré de protection</i>	IP 44
Medidas <i>Dimensions / Dimensions</i>	L1: 467
	L2: 449
	Ø: 45

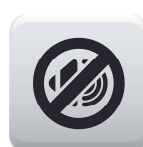

MOTORES TUBULARES

TUBULAR MOTORS / MOTEURS TUBULAIRES

GLB



INFORMACIÓN TÉCNICA TECHNICAL INFORMATION / INFORMATION TECHNIQUE	DM45S 20/15
Alimentación <i>Power supply / Tension nominal-Fréquence</i>	230V / 50Hz
Potencia <i>Rated power / Puissance nominale</i>	145 W
Intensidad <i>Rated current / Courant nominal</i>	0.64 A
Par motor <i>Rated torque / Couple nominal</i>	20 Nm
Revoluciones <i>Rated speed / Vitesse nominale</i>	15 rpm
Número máximo de vueltas de recorrido <i>Max number of turns / Nombre maximum de tours de voyage</i>	22
Tiempo de funcionamiento continuo <i>Running time / Temps de travail continu</i>	4 min.
Protección <i>Degree of protection / Degré de protection</i>	IP 44
Medidas <i>Dimensions / Dimensions</i>	L1: 467
	L2: 449
	Ø: 45



MOTORES TUBULARES

GLB

TUBULAR MOTORS / MOTEURS TUBULAIRES

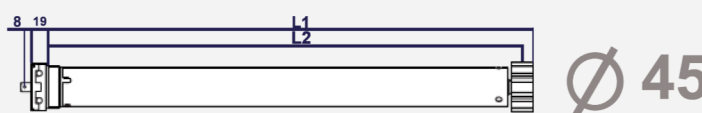

INFORMACIÓN TÉCNICA <i>TECHNICAL INFORMATION / INFORMATION TECHNIQUE</i>	DM45S 30/15
Alimentación <i>Power supply / Tension nominal-Fréquence</i>	230V / 50Hz
Potencia <i>Rated power / Puissance nominale</i>	191 W
Intensidad <i>Rated current / Courant nominal</i>	0.83 A
Par motor <i>Rated torque / Couple nominal</i>	30 Nm
Revoluciones <i>Rated speed / Vitesse nominale</i>	15 rpm
Número máximo de vueltas de recorrido <i>Max number of turns / Nombre maximum de tours de voyage</i>	22
Tiempo de funcionamiento continuo <i>Running time / Temps de travail continu</i>	4 min.
Protección <i>Degree of protection / Degré de protection</i>	IP 44
Medidas <i>Dimensions / Dimensions</i>	L1: 537
	L2: 519
	Ø: 45

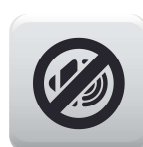

MOTORES TUBULARES

GLB

TUBULAR MOTORS / MOTEURS TUBULAIRES

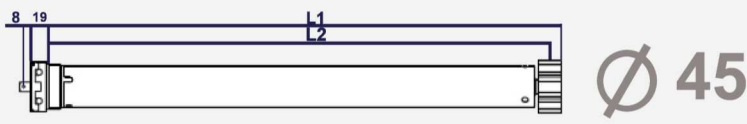

INFORMACIÓN TÉCNICA <i>TECHNICAL INFORMATION / INFORMATION TECHNIQUE</i>	DM45S 50/12
Alimentación <i>Power supply / Tension nominal-Fréquence</i>	230V / 50Hz
Potencia <i>Rated power / Puissance nominale</i>	205 W
Intensidad <i>Rated current / Courant nominal</i>	0.89 A
Par motor <i>Rated torque / Couple nominal</i>	40 Nm
Revoluciones <i>Rated speed / Vitesse nominale</i>	12 rpm
Número máximo de vueltas de recorrido <i>Max number of turns / Nombre maximum de tours de voyage</i>	22
Tiempo de funcionamiento continuo <i>Running time / Temps de travail continu</i>	4 min.
Protección <i>Degree of protection / Degré de protection</i>	IP 44
Medidas <i>Dimensions / Dimensions</i>	L1: 537
	L2: 519
	Ø: 45

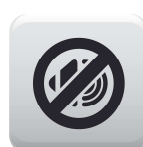

MOTORES TUBULARES

GLB

TUBULAR MOTORS / MOTEURS TUBULAIRES

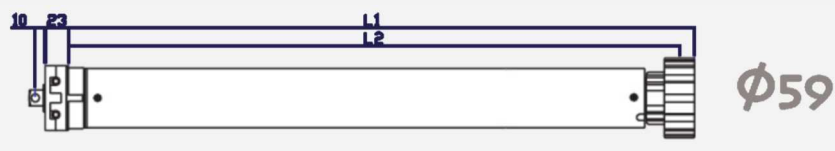

INFORMACIÓN TÉCNICA <i>TECHNICAL INFORMATION / INFORMATION TECHNIQUE</i>	DM59S 80/15
Alimentación <i>Power supply / Tension nominal-Fréquence</i>	230V / 50Hz
Potencia <i>Rated power / Puissance nominale</i>	330 W
Intensidad <i>Rated current / Courant nominal</i>	1.43 A
Par motor <i>Rated torque / Couple nominal</i>	80 Nm
Revoluciones <i>Rated speed / Vitesse nominale</i>	15 rpm
Número máximo de vueltas de recorrido <i>Max number of turns / Nombre maximum de tours de voyage</i>	22
Tiempo de funcionamiento continuo <i>Running time / Temps de travail continu</i>	4 min.
Protección <i>Degree of protection / Degré de protection</i>	IP 44
Medidas <i>Dimensions / Dimensions</i>	L1: 599
	L2: 584
	Ø: 59

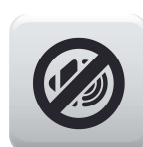

MOTORES TUBULARES

GLB

TUBULAR MOTORS / MOTEURS TUBULAIRES

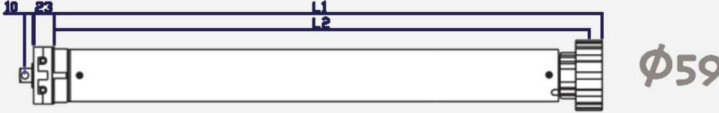

INFORMACIÓN TÉCNICA <i>TECHNICAL INFORMATION / INFORMATION TECHNIQUE</i>	DM59S 100/9
Alimentación <i>Power supply / Tension nominal-Fréquence</i>	230V / 50Hz
Potencia <i>Rated power / Puissance nominale</i>	340 W
Intensidad <i>Rated current / Courant nominal</i>	1.52 A
Par motor <i>Rated torque / Couple nominal</i>	100 Nm
Revoluciones <i>Rated speed / Vitesse nominale</i>	9 rpm
Número máximo de vueltas de recorrido <i>Max number of turns / Nombre maximum de tours de voyage</i>	22
Tiempo de funcionamiento continuo <i>Running time / Temps de travail continu</i>	4 min.
Protección <i>Degree of protection / Degré de protection</i>	IP 44
Medidas <i>Dimensions / Dimensions</i>	L1: 599
	L2: 584
	Ø: 59

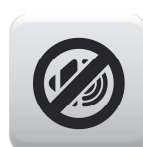

MOTORES TUBULARES

GLB

TUBULAR MOTORS / MOTEURS TUBULAIRES



INFORMACIÓN TÉCNICA TECHNICAL INFORMATION / INFORMATION TECHNIQUE	DM59S 120/9
Alimentación <i>Power supply / Tension nominal-Fréquence</i>	230V / 50Hz
Potencia <i>Rated power / Puissance nominale</i>	350 W
Intensidad <i>Rated current / Courant nominal</i>	1.56 A
Par motor <i>Rated torque / Couple nominal</i>	120 Nm
Revoluciones <i>Rated speed / Vitesse nominale</i>	9 rpm
Número máximo de vueltas de recorrido <i>Max number of turns / Nombre maximum de tours de voyage</i>	22
Tiempo de funcionamiento continuo <i>Running time / Temps de travail continu</i>	4 min.
Protección <i>Degree of protection / Degré de protection</i>	IP 44
Medidas <i>Dimensions / Dimensions</i>	L1: 599
	L2: 584
	Ø: 59

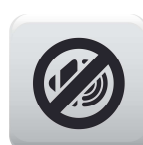
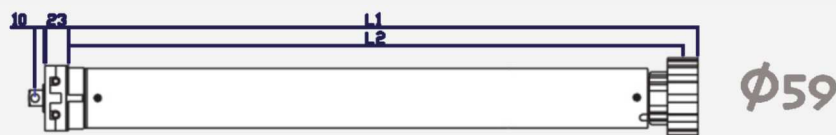

MOTORES TUBULARES

TUBULAR MOTORS / MOTEURS TUBULAIRES

GLB



INFORMACIÓN TÉCNICA TECHNICAL INFORMATION / INFORMATION TECHNIQUE	DM35T 10/17
Alimentación <i>Power supply / Tension nominal-Fréquence</i>	230V / 50Hz
Potencia <i>Rated power / Puissance nominale</i>	121 W
Intensidad <i>Rated current / Courant nominal</i>	0.53 A
Par motor <i>Rated torque / Couple nominal</i>	10 Nm
Revoluciones <i>Rated speed / Vitesse nominale</i>	17 rpm
Número máximo de vueltas de recorrido <i>Max number of turns / Nombre maximum de tours de voyage</i>	17
Tiempo de funcionamiento continuo <i>Running time / Temps de travail continu</i>	4 min.
Protección <i>Degree of protection / Degré de protection</i>	IP 44
Medidas <i>Dimensions / Dimensions</i>	L1: 407
	L2: 397
	Ø: 35

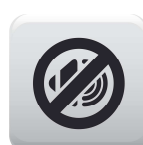
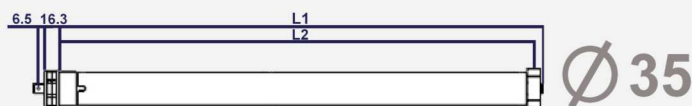

MOTORES TUBULARES

GLB

TUBULAR MOTORS / MOTEURS TUBULAIRES



INFORMACIÓN TÉCNICA TECHNICAL INFORMATION / INFORMATION TECHNIQUE		DM45T 20/15
Alimentación <i>Power supply / Tension nominal-Fréquence</i>		230V / 50Hz
Potencia <i>Rated power / Puissance nominale</i>		149 W
Intensidad <i>Rated current / Courant nominal</i>		0.53 A
Par motor <i>Rated torque / Couple nominal</i>		20 Nm
Revoluciones <i>Rated speed / Vitesse nominale</i>		15 rpm
Número máximo de vueltas de recorrido <i>Max number of turns / Nombre maximum de tours de voyage</i>		16
Tiempo de funcionamiento continuo <i>Running time / Temps de travail continu</i>		4 min.
Protección <i>Degree of protection / Degré de protection</i>		IP 44
Medidas <i>Dimensions / Dimensions</i>		
	L1:	384
	L2:	344
	Ø:	45

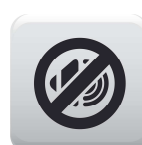

MOTORES TUBULARES

GLB

TUBULAR MOTORS / MOTEURS TUBULAIRES

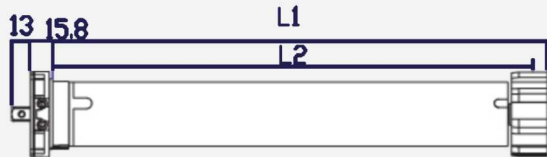

INFORMACIÓN TÉCNICA <i>TECHNICAL INFORMATION / INFORMATION TECHNIQUE</i>	DM44S 30/13
Alimentación <i>Power supply / Tension nominal-Fréquence</i>	120V / 60Hz
Potencia <i>Rated power / Puissance nominale</i>	152 W
Intensidad <i>Rated current / Courant nominal</i>	1.51 A
Par motor <i>Rated torque / Couple nominal</i>	30 Nm
Revoluciones <i>Rated speed / Vitesse nominale</i>	13 rpm
Número máximo de vueltas de recorrido <i>Max number of turns / Nombre maximum de tours de voyage</i>	22
Tiempo de funcionamiento continuo <i>Running time / Temps de travail continu</i>	4 min.
Protección <i>Degree of protection / Degré de protection</i>	IP 44
Medidas <i>Dimensions / Dimensions</i>	L1: 557
	L2: 539
	Ø: 45

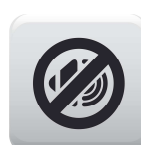

7 Instalación del circuito C

230 V/50 Hz o 120 V/60 Hz de acuerdo con la placa de identificación del producto

AC	L	N	⊕
	Fase	Neutro	Tierra

Legend for wiring colors:

- 330V/50Hz: 1 Azul = Neutro, 2 Negro = Fase 1, 3 Marrón = Fase 2, 4 Verde/amarillo = Tierra
- 120V/60Hz: 1 Blanco = Neutro, 2 Rojo = Fase 1, 3 Negro = Fase 2, 4 Verde = Tierra

Motor tubular estándar

Especificaciones

S. Límite Mecánico Estándar

Por DM35S, DM45S, DM59S, DM45SD



8 Configuración del límite superior

Una vez apagado el motor, deje de girar la tuerca roja o blanca con el regulador.

ok
La configuración del límite superior se ha realizado correctamente.

Versión n.º: A/02

T Placa de identificación del producto

Soporte Técnico



Par nominal	20N.m	15min ⁻¹	Modelo del motor	TUBULAR MOTOR DM45S-20
Tensión nominal	230V	50Hz	Velocidad nominal	15min ⁻¹
Potencia nominal	145W	0,64A	Diámetro del tubo del motor	Ø45
Peso del motor	2,05Kg	IP44	Certificado del producto	CE
		I.c.L.H.	Grado de aislamiento	I.c.L.H.
			Grado de protección	

Modelo del motor: **DM 45 S - 20 / 15**

Motor tubular, Diámetro del tubo, Tipo estándar, Par nominal (n.m), Velocidad nominal (rpm)

9 Configuración del límite inferior

Una vez apagado el motor, deje de girar la tuerca roja o blanca con el regulador.

ok
La configuración del límite inferior se ha realizado correctamente.

T Instrucciones del motor

Soporte Técnico

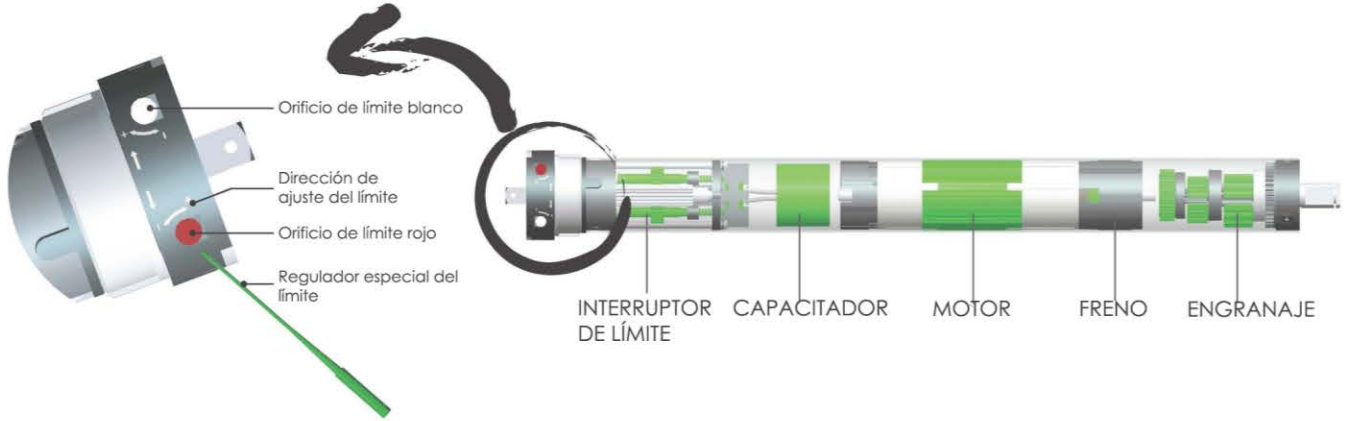

! Problemas frecuentes y soluciones

Attention

	Problemas	Causas del problema	Resolución del problema
1	Se pulsa el botón UP del controlador, la persiana se desplaza hacia abajo.	La conexión de los cables internos del controlador es incorrecta	Intercambie la posición de los cables negro y marrón.
2	Al encenderlo, el adaptador de la unidad solo funciona en una dirección	El interruptor del límite interior del motor no se abre	Desplazar la corona circularmente en la dirección opuesta a la del adaptador de la unidad para que funcione.
3	Al conectar la alimentación, el motor se inicia lentamente o no funciona.	a. La tensión eléctrica es baja b. Error de cableado c. Sobrecarga d. Instalación incorrecta	a. Ajustar la potencia a los datos nominales b. Comprobar el circuito y corregir las conexiones erróneas c. Par nominal asociado con la instalación de la carga d. Reinstalar el motor
4	El motor se detiene bruscamente tras funcionar de forma normal.	El motor se detiene bruscamente tras funcionar de forma normal.	El motor se volverá a encender automáticamente tras un periodo de reposo de 20 minutos
5	Sonido anormal durante el funcionamiento de la persiana	El tubo exterior es demasiado largo, lo que hace que la conexión de la persiana con ambos soportes esté demasiado ajustada.	Acortar el tubo para evitar un ajuste demasiado apretado

A Sistema de control compatible

Soporte Técnico



Otros sistemas de control





Atención

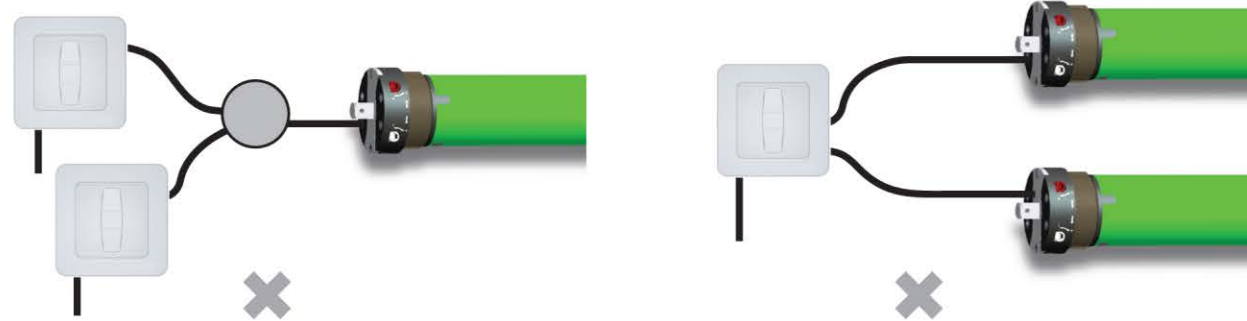

3

Instalación de los soportes A

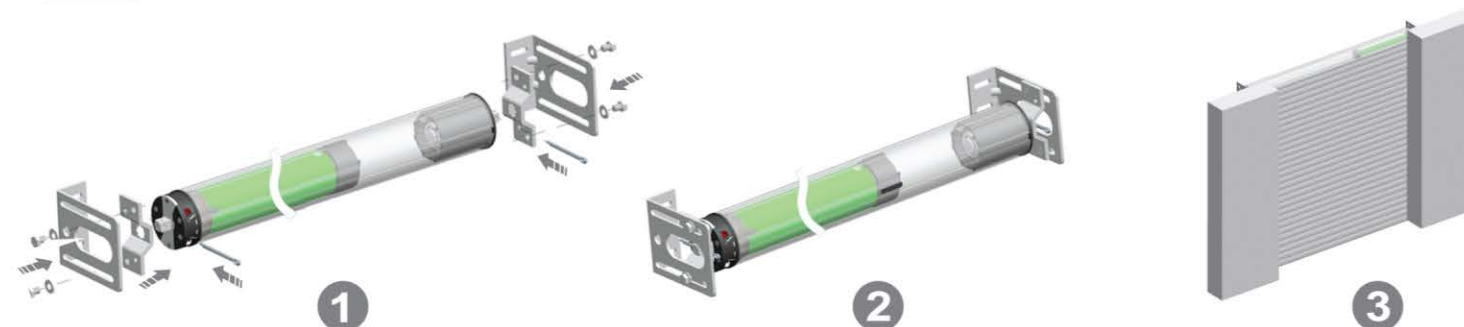

4

Instalación de los soportes B

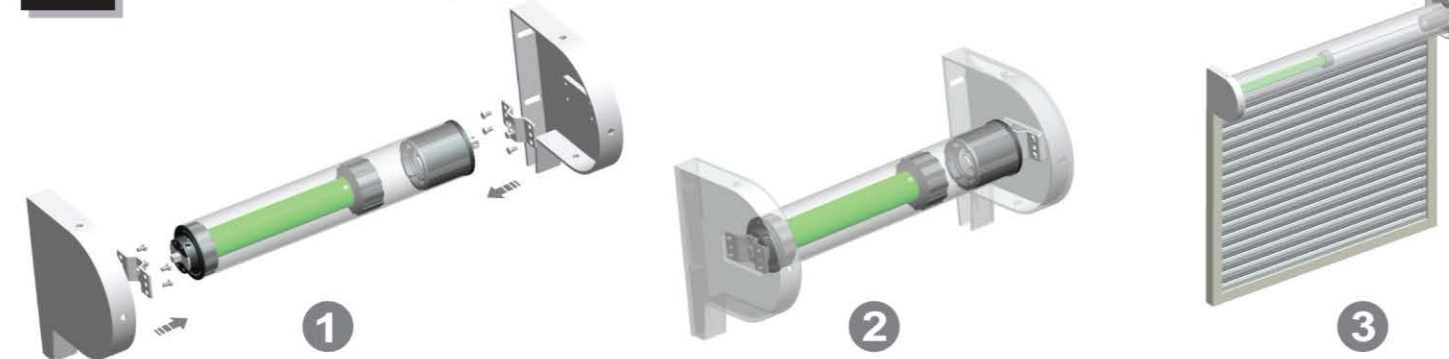

1

Instalación de la corona

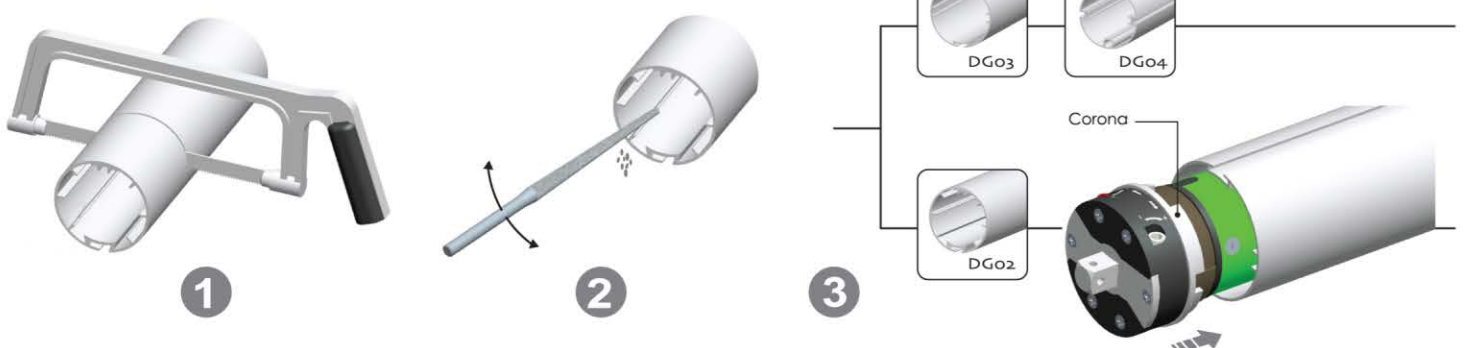

5

Instalación del circuito A

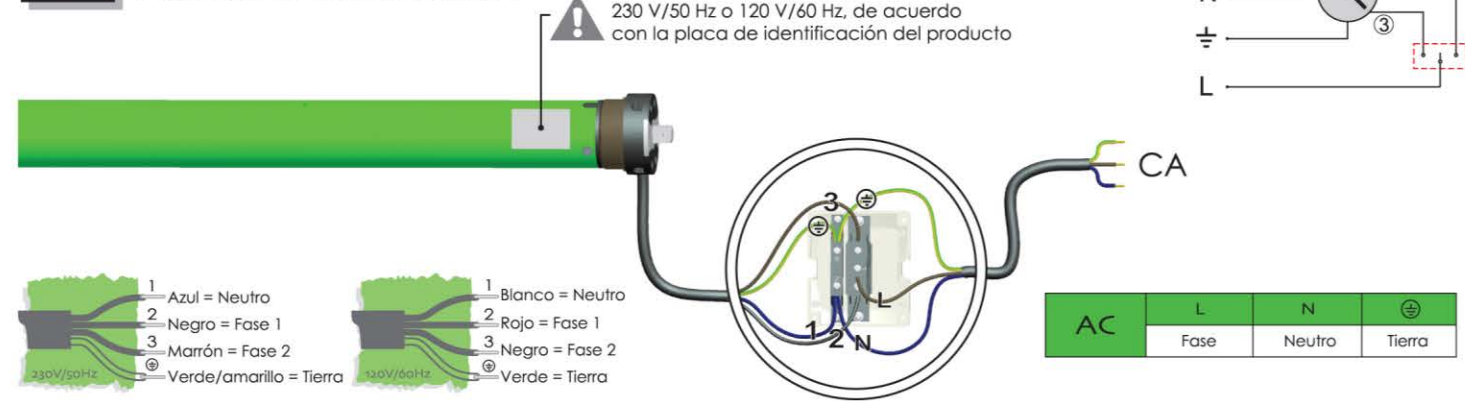

2

Instalación del adaptador de la unidad

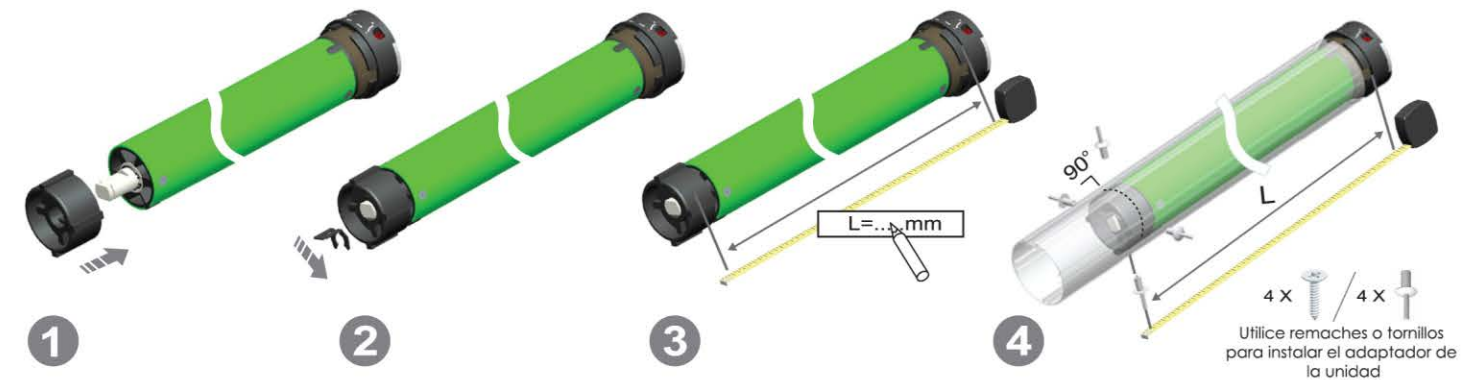

6

Instalación del circuito B

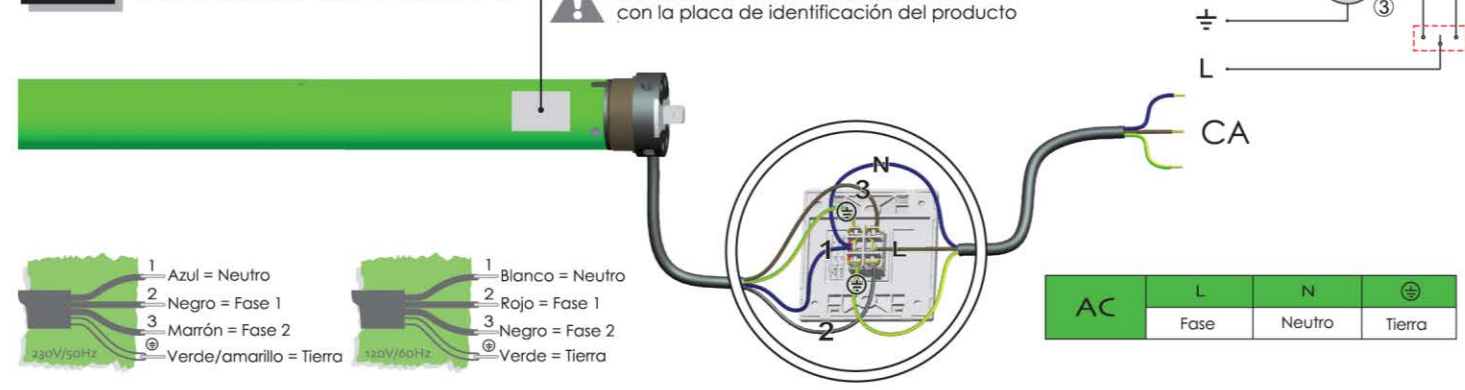

7

Circuit installation C

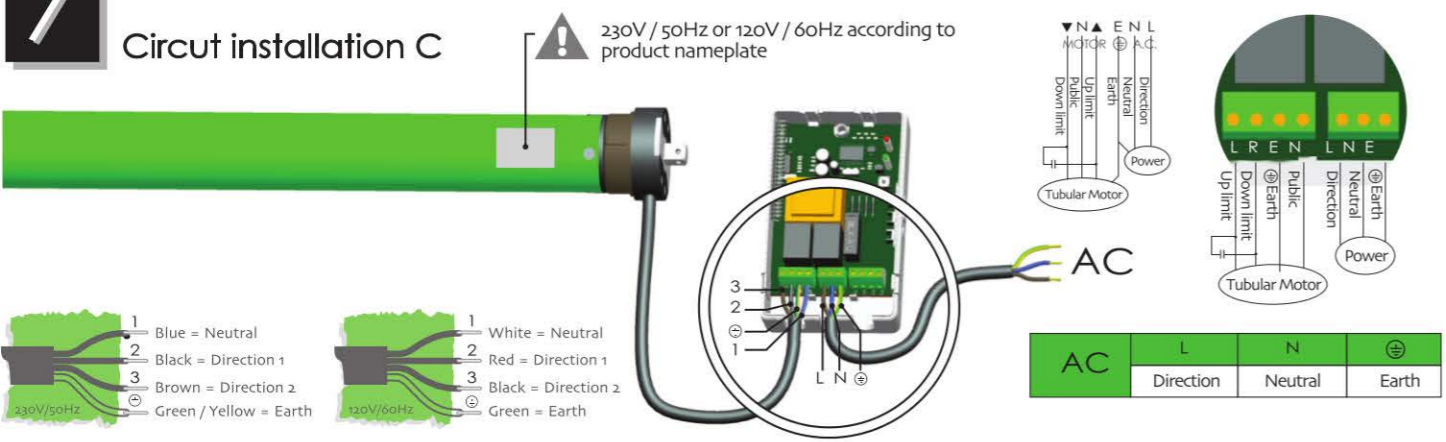

Standard Tubular Motor Specification

S: Standard
Mechanic Limit

By DM35S
DM45S
DM59S
DM45SD



8

Up limit setting

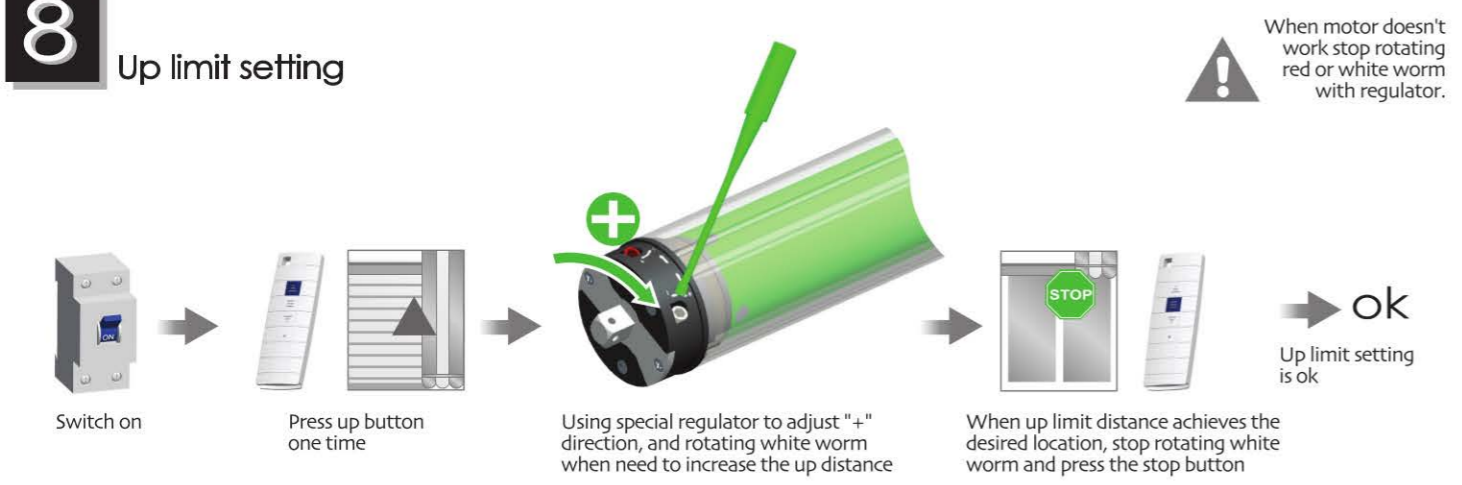

9

Down limit setting

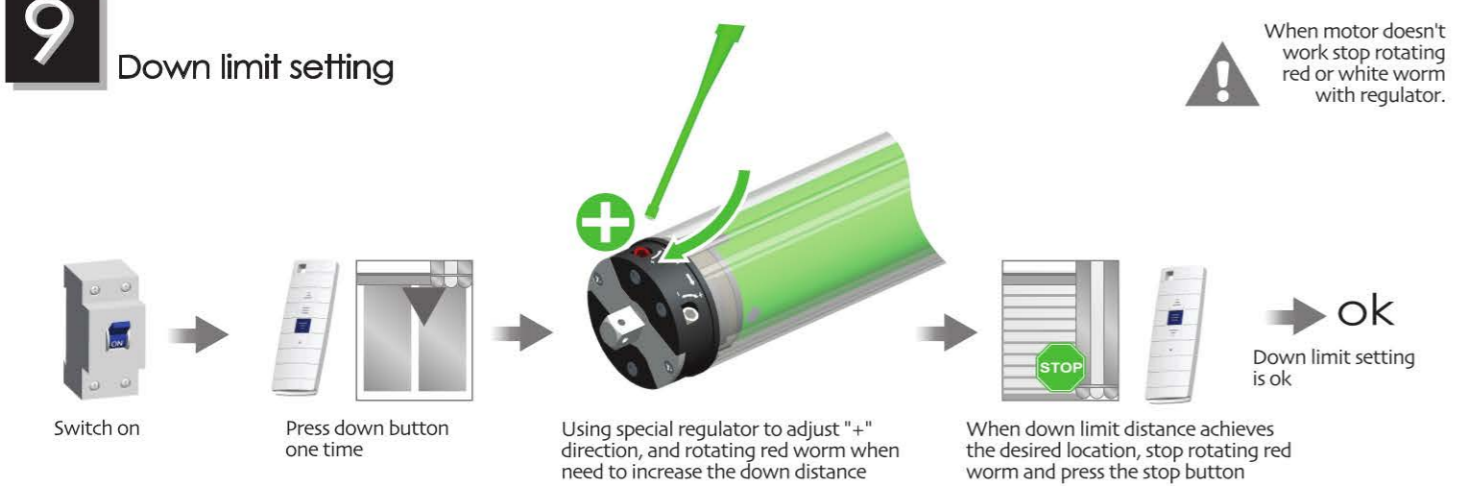

T

Product Nameplate

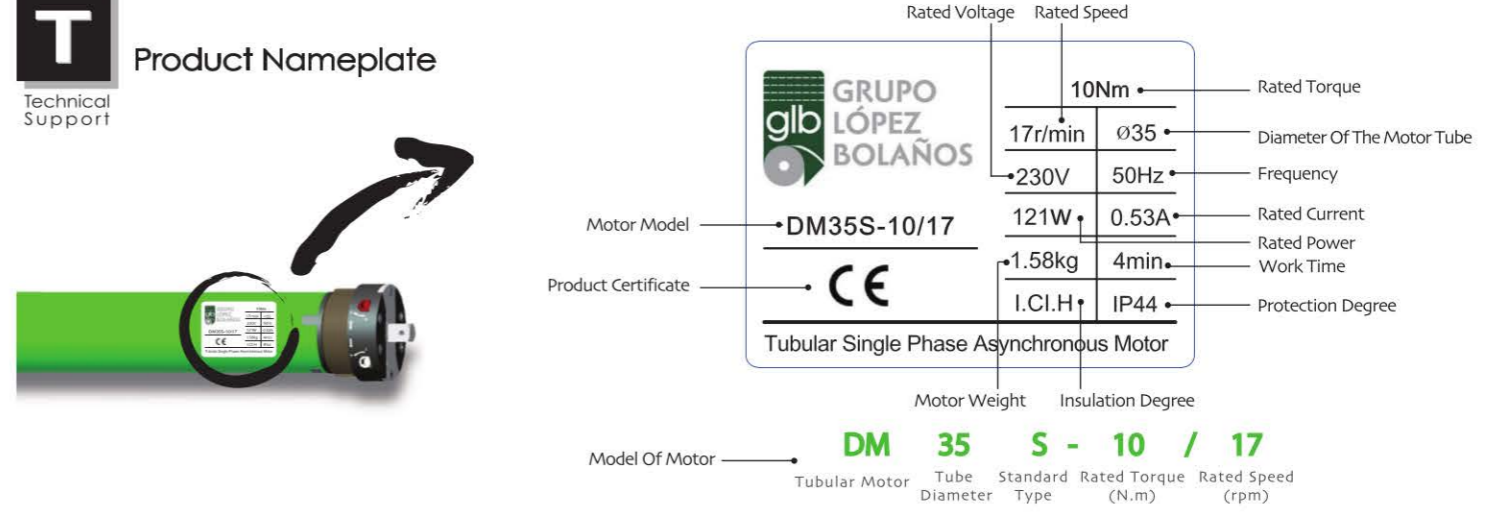

T

Instruction Of The Motor

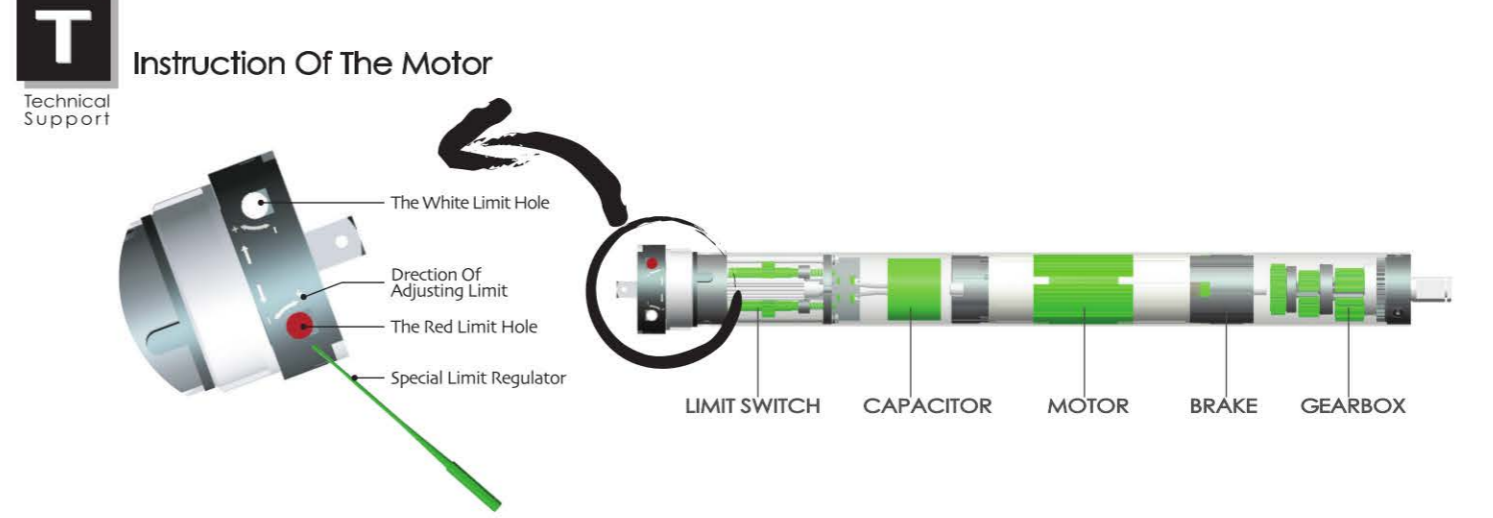

!

Common failures and solutions

Attention	Fail-phenomena	Failure causes	solutions failure recovery
1	Press the upward button of the controller, the shutter move downward	Inside wire connecting of the controller is wrong	Exchange the position of black wire and brown wire
2	Switch on, the drive adapter runs in one-way operation	Inside limit switch of motor doesn't open	Crown running one circle in the opposite direction of the drive adapter, then it works
3	motor starts slowly or not work after connect power	a. Power voltage is low b. Wiring error c. Overload d. Improper installation	a. Adjust power to rated data b. Check circuit and correct wiring connecting c. Rated torque associated with the installation of the load d. Re-install the motor
4	Motor stops suddenly after running	Motor stops suddenly after running	Motor will automatically resume work after 20 minutes cooling
5	Abnormal sound during roller blinds in operation	Outer tube is too long, led the rolling shutter connects with both sides of bracket too tightly	If idler is active, propering make the tube shorter to avoid too tight status.

A

Matchable Control System



Others Control System



! Attention

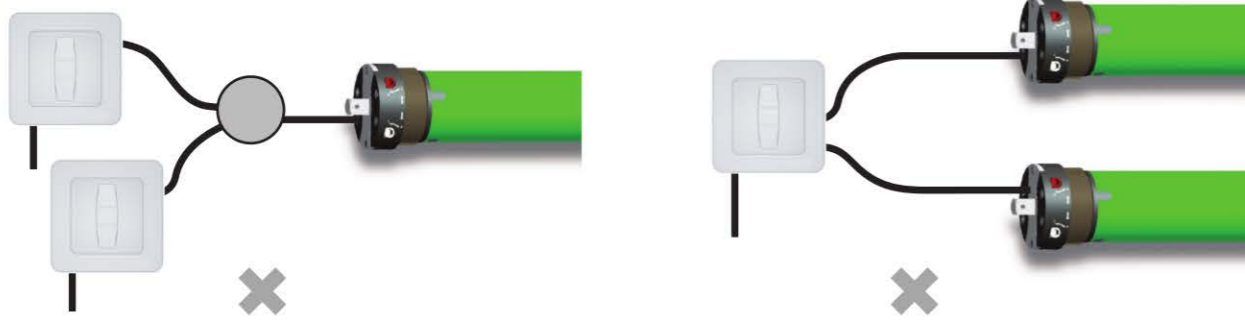

1 Crown installation

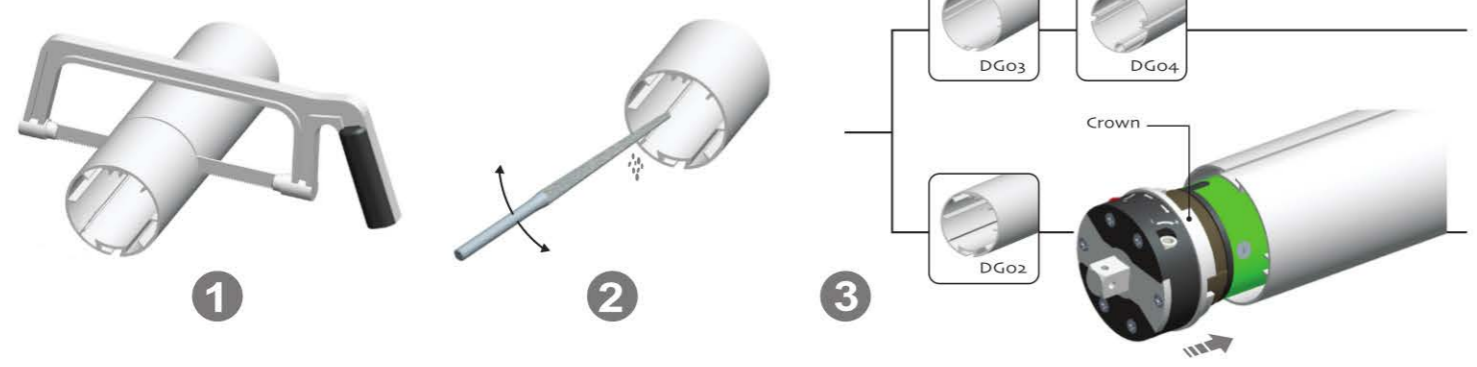

2 Drive adapter installation

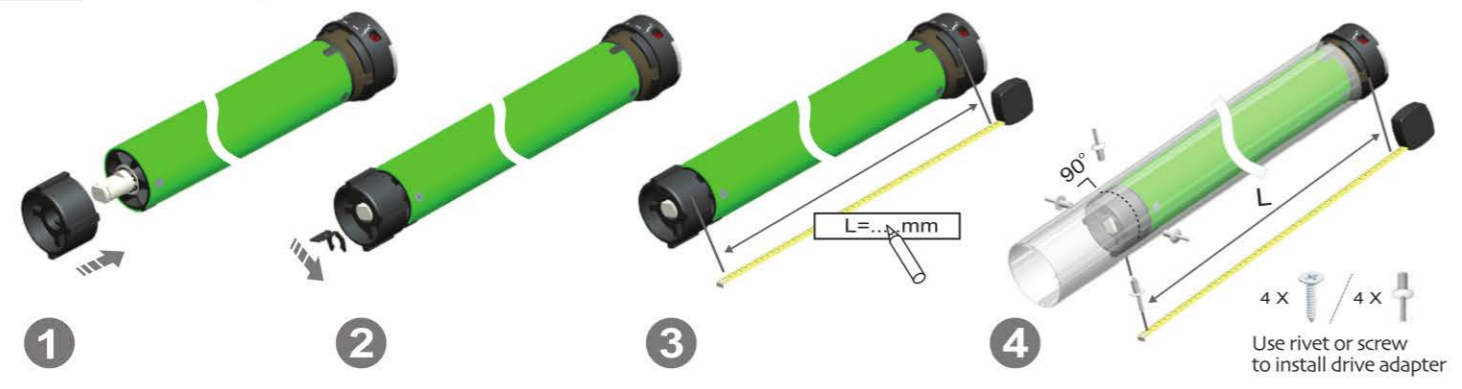

3 Bracket installation A

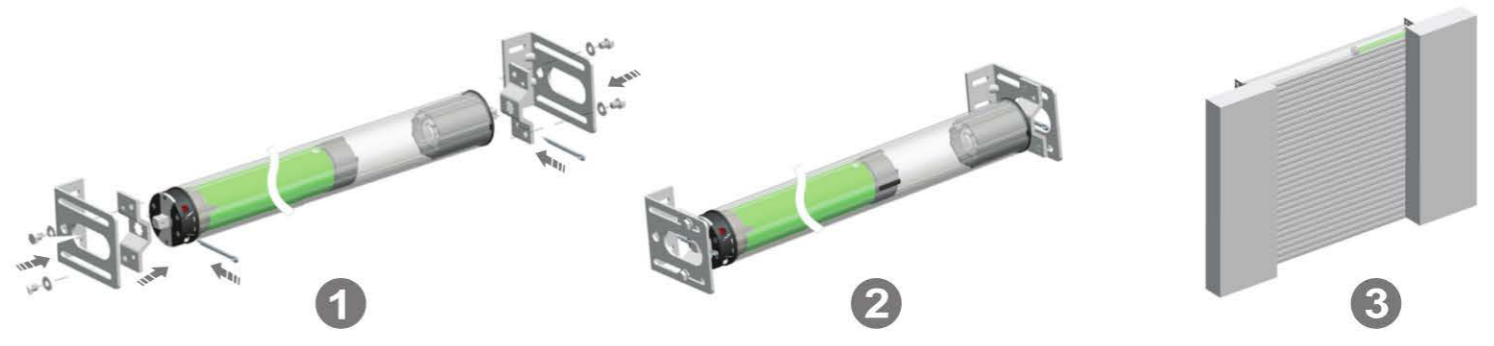

4 Bracket installation B

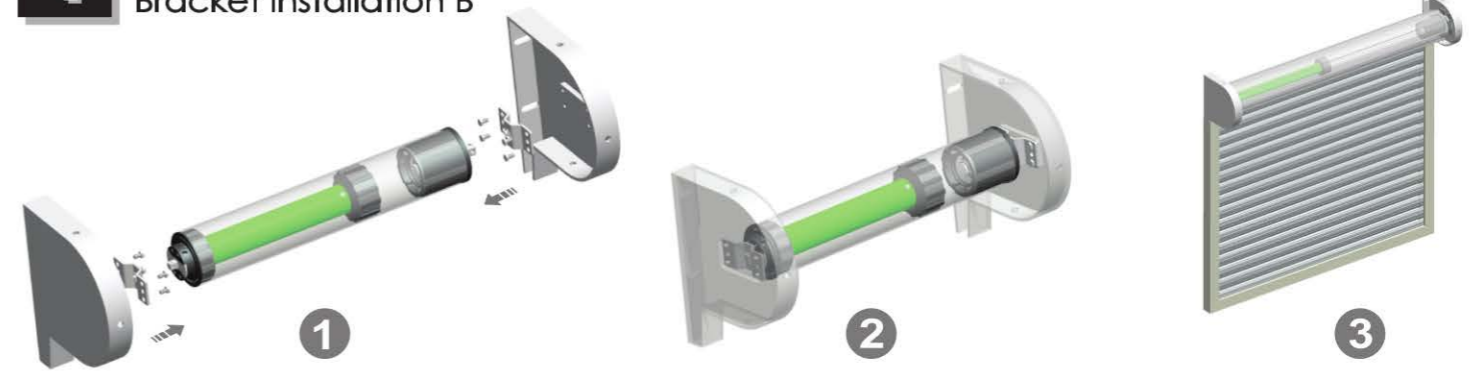

5 Circuit installation A

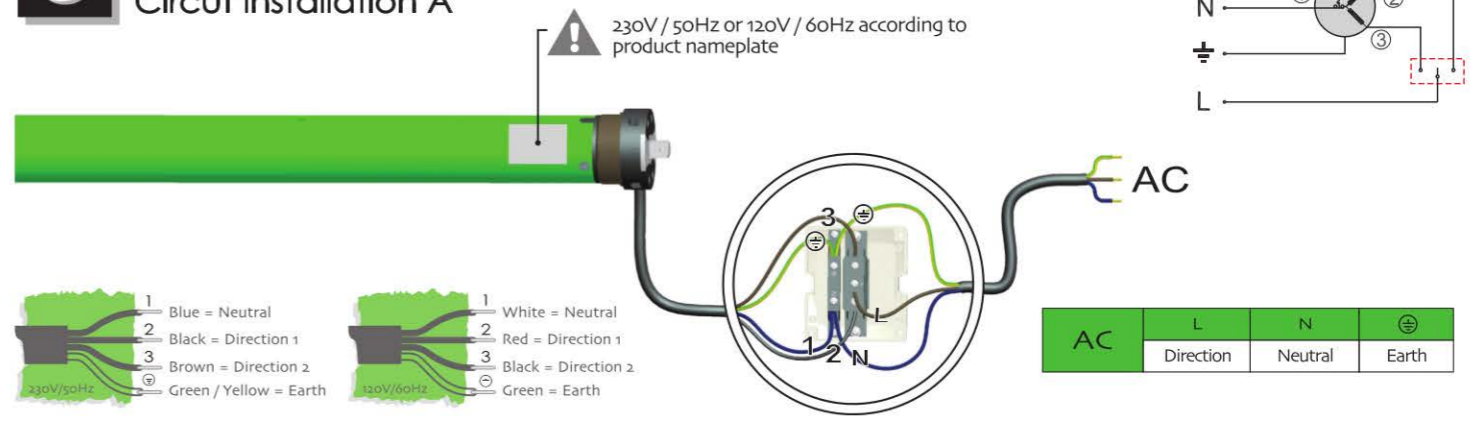

6 Circuit installation B

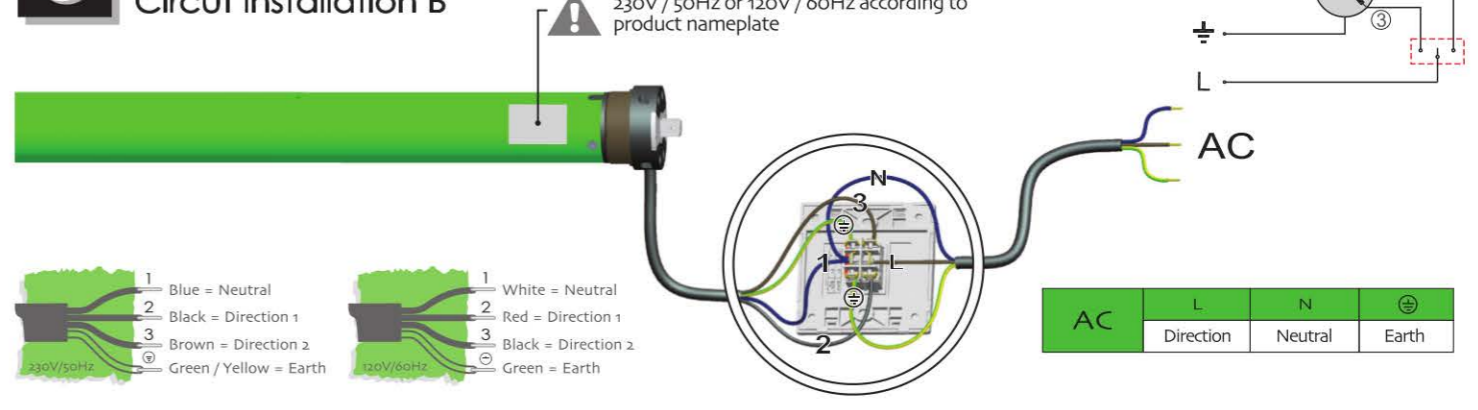

7 Installation du circuit C

230 V/50 Hz ou 120 V/60 Hz conformément à la plaque d'identification du produit

1 Bleu = Neutre
2 Noir = Phase 1
3 Marron = Phase 2
4 Vert/jaune = Terre

1 Blanc = Neutre
2 Rouge = Phase 1
3 Noir = Phase 2
4 Vert = Terre

AC L N Earth
Phase Neutre Terre

Moteur tubulaire standard

Spécifications

S: Standard
Limite mécanique
Par DM35S
DM45S
DM59S
DM45SD



8 Configuration de la limite supérieure

Une fois que le moteur sera éteint, ne faites plus tourner l'écrou rouge ou blanc avec le régulateur

Allumage

Appuyez une seule fois sur la touche MONTÉE (flèche vers le haut)

Utilisez le régulateur spécial pour régler dans le sens « + » la direction et faites tourner l'écrou blanc s'il est nécessaire d'augmenter la distance supérieure.

Une fois que vous aurez obtenu la limite supérieure de la distance souhaitée, ne faites plus tourner l'écrou blanc et appuyez sur la touche ARRÊT

ok
La configuration de la limite supérieure s'est réalisée correctement

Version n: A/02

T Plaque d'identification du produit

Assistance technique

Courant nominal	Fréquence	Temps de travail	Modèle du moteur
Couple nominal	Tension nominale	Vitesse nominale	Diamètre du tube du moteur
Puissance nominale	Poids du moteur	Degré d'isolation	Degré de protection

TUBULAR MOTOR DM45S-20

20N.m, 15min⁻¹, 230V, 50Hz, 145W, 0,64A, 2,05Kg, IP44, I.c.L.H.

Modèle du moteur → **DM 45 S - 20 / 15**

Moteur tubulaire, Diamètre du tube, Type standard, Couple nominal (n.m), Vitesse nominale (rpm)

9 Configuration de la limite inférieure

Une fois que le moteur sera éteint, ne faites plus tourner l'écrou rouge ou blanc avec le régulateur

Allumage

Appuyez une fois sur la touche DESCENTE (flèche vers le bas)

Utilisez le régulateur spécial pour régler dans le sens « + » la direction et faites tourner l'écrou rouge s'il est nécessaire d'augmenter la distance inférieure.

Une fois que vous aurez atteint la limite inférieure de la distance souhaitée, faites tourner l'écrou rouge et appuyez sur la touche ARRÊT.

ok
La configuration de la limite inférieure s'est réalisée correctement.

T Mode d'emploi du moteur

Assistance technique

Orifice de limite blanc
Sens de l'ajustement de la limite
Orifice de limite rouge
Régulateur spécial de la limite

INTERRUPTEUR DE LIMITE, CONDENSATEUR, MOTEUR, FREINS, ENGRENAGE

! Problèmes fréquents et solutions

Attention

Problèmes	Causes du problème	Résolution du problème
1 En appuyant sur la touche UP du contrôleur, la persienne descend.	La connexion des câbles internes du contrôleur est incorrecte	Changez la position des câbles noir et marron.
2 En l'allumant, l'adaptateur de l'unité fonctionne en une seule direction	L'interrupteur de la limite inférieure du moteur ne s'ouvre pas	Déplacez la couronne de façon circulaire dans le sens opposé à celui de l'adaptateur de l'unité afin de le faire marcher
3 En branchant l'alimentation, le moteur démarre très lentement ou ne fonctionne pas	a. La tension électrique est faible b. Erreur de câblage c. Surcharge d. Installation incorrecte	a. Ajustez la puissance des données nominales b. Vérifiez le circuit et corrigez les connexions erronées c. Couple nominal associé avec l'installation de la charge d. Réinstallez le moteur
4 Le moteur s'arrête brusquement après une période de fonctionnement normal	Le moteur s'arrête brusquement après une période de fonctionnement normal	Le moteur se rallumera automatiquement après un temps de repos de 20 minutes
5 Bruit anormal pendant le fonctionnement de la persienne	Le tube extérieur est trop long, ce qui provoque que la connexion de la persienne avec les deux supports soit trop serrée	Raccourcir le tube afin d'éviter un ajustement trop serré.

A Système de contrôle compatible

Soporte Técnico

DC41, DC42, DC73, DC74, DC43, DC83

MONTÉE, ARRÊT, DESCENTE

- Fréquence de l'émission : 433,92 MHz ±100 KHz
- Température de travail : de -20 °C à +55 °C
- Sensible au toucher
- Mouvement ponctuel
- Fonction d'inversion du sens
- Compatible avec tous les émetteurs sans fil
- Distance de transmission: extérieure 200 mètres, intérieure 35 mètres

Autres systèmes de contrôle

Interrupteur manuel simple (mécanique) DC59, Interrupteur simple sensible au toucher (électronique) DC63, Interrupteur manuel simple (mécanique) DC25, Interrupteur manuel sencillo (mecánico) DC27, Contrôle central de 4 canaux DC80, UPS DC51



Attention

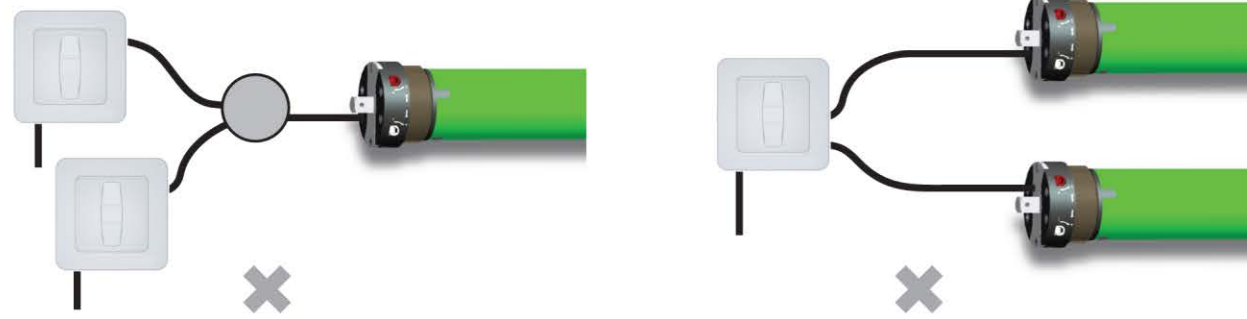

3

Installation des supports A

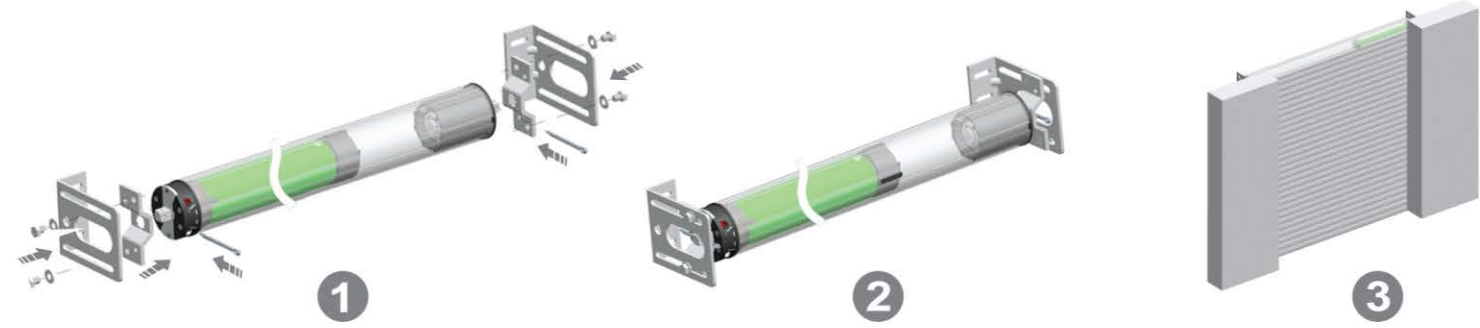

4

Installation des supports B

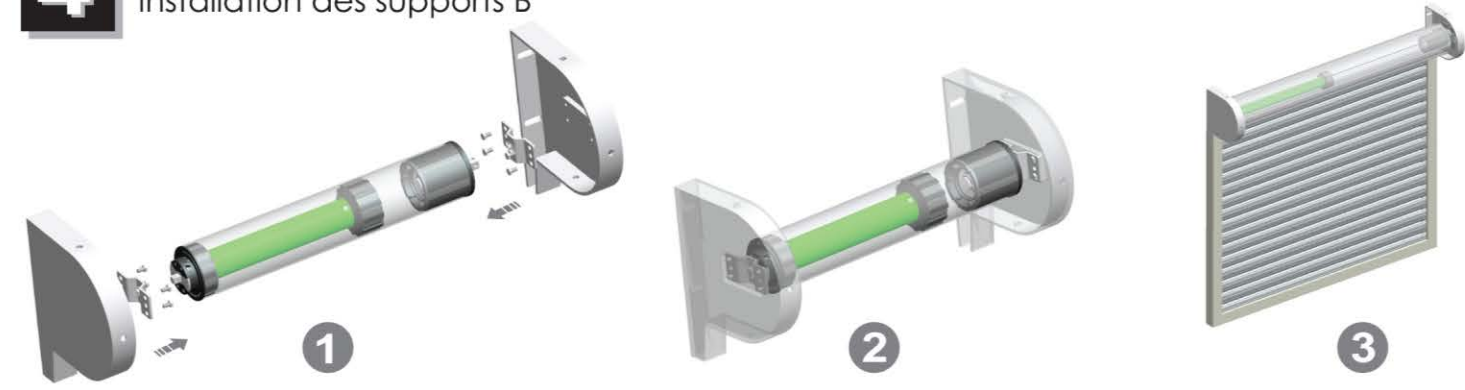

1

Installation de la couronne

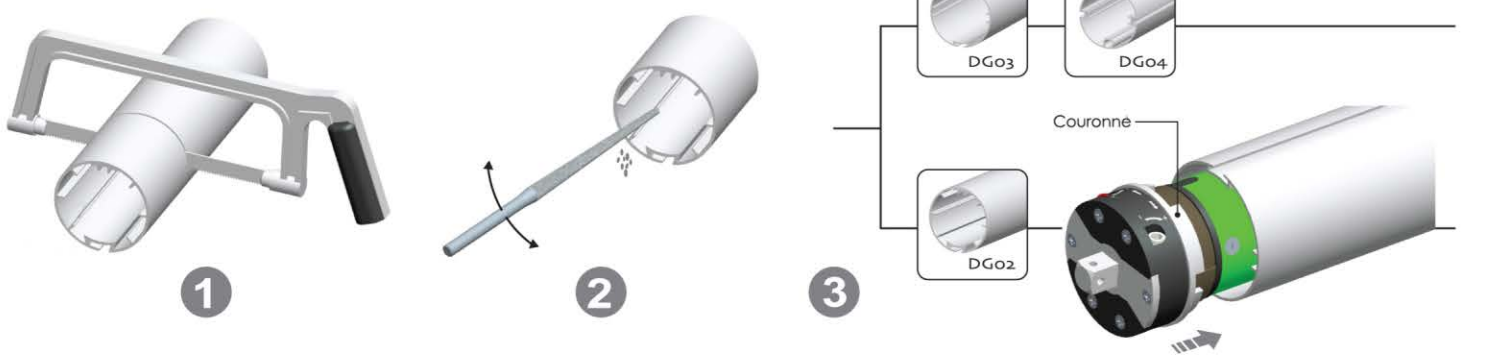

5

Installation du circuit A

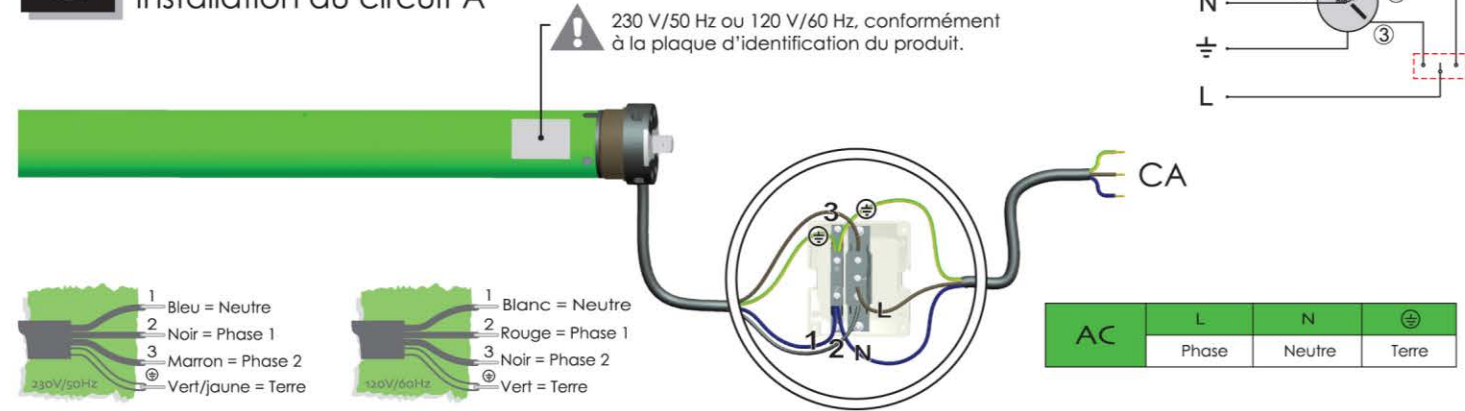

2

Installation de l'adaptateur de l'unité

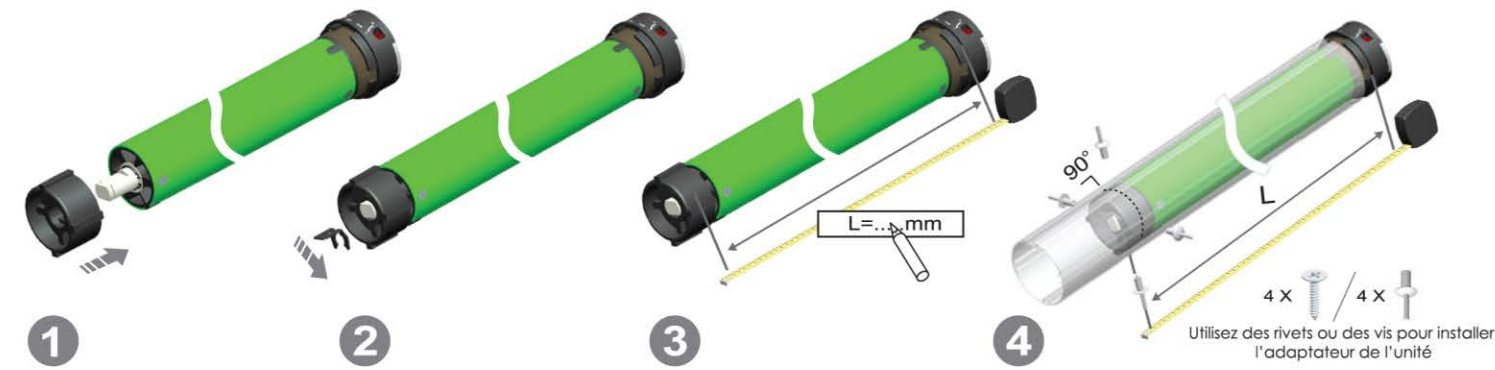

6

Installation du circuit B

