

MOTORES TUBULARES

GLB

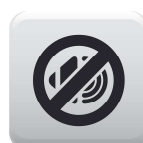

INFORMACIÓN TÉCNICA TECHNICAL INFORMATION / INFORMATION TECHNIQUE	DM35R 10/17						
Alimentación <i>Power supply / Tension nominal-Fréquence</i>	230V / 50Hz						
Potencia <i>Rated power / Puissance nominale</i>	121 W						
Intensidad <i>Rated current / Courant nominal</i>	0.53 A						
Par motor <i>Rated torque / Couple nominal</i>	10 Nm						
Revoluciones <i>Rated speed / Vitesse nominale</i>	17 rpm						
Número máximo de vueltas de recorrido <i>Max number of turns / Nombre máximo de tours de voyage</i>	36						
Tiempo de funcionamiento continuo <i>Running time / Temps de travail continu</i>	4 min.						
Protección <i>Degree of protection / Degré de protection</i>	IP 44						
Medidas <i>Dimensions / Dimensions</i>	<table border="1"> <tr> <td data-bbox="1026 1581 1194 1637">L1:</td> <td data-bbox="1194 1581 1547 1637">577</td> </tr> <tr> <td data-bbox="1026 1637 1194 1736">L2:</td> <td data-bbox="1194 1637 1547 1736">564</td> </tr> <tr> <td data-bbox="1026 1736 1194 1825">Ø:</td> <td data-bbox="1194 1736 1547 1825">35</td> </tr> </table>	L1:	577	L2:	564	Ø:	35
L1:	577						
L2:	564						
Ø:	35						

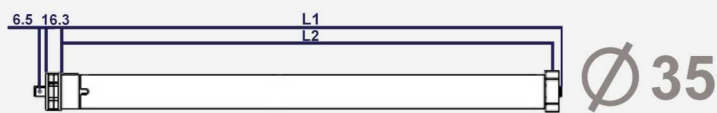

MOTORES TUBULARES

GLB



INFORMACIÓN TÉCNICA <i>TECHNICAL INFORMATION / INFORMATION TECHNIQUE</i>	DM45R 10/15	
Alimentación <i>Power supply / Tension nominal-Fréquence</i>	230V / 50Hz	
Potencia <i>Rated power / Puissance nominale</i>	112 W	
Intensidad <i>Rated current / Courant nominal</i>	0.49 A	
Par motor <i>Rated torque / Couple nominal</i>	10 Nm	
Revoluciones <i>Rated speed / Vitesse nominale</i>	15 rpm	
Número máximo de vueltas de recorrido <i>Max number of turns / Nombre máximo de tours de voyage</i>	45	
Tiempo de funcionamiento continuo <i>Running time / Temps de travail continu</i>	4 min.	
Protección <i>Degree of protection / Degré de protection</i>	IP 44	
Medidas <i>Dimensions / Dimensions</i>	L1: 595	L2: 574
	Ø: 45	

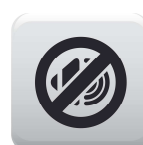

MOTORES TUBULARES

GLB



INFORMACIÓN TÉCNICA TECHNICAL INFORMATION / INFORMATION TECHNIQUE	DM45R 20/15	
Alimentación <i>Power supply / Tension nominal-Fréquence</i>	230V / 50Hz	
Potencia <i>Rated power / Puissance nominale</i>	145 W	
Intensidad <i>Rated current / Courant nominal</i>	0.64 A	
Par motor <i>Rated torque / Couple nominal</i>	20 Nm	
Revoluciones <i>Rated speed / Vitesse nominale</i>	15 rpm	
Número máximo de vueltas de recorrido <i>Max number of turns / Nombre máximo de tours de voyage</i>	45	
Tiempo de funcionamiento continuo <i>Running time / Temps de travail continu</i>	4 min.	
Protección <i>Degree of protection / Degré de protection</i>	IP 44	
Medidas <i>Dimensions / Dimensions</i>	L1: 595 L2: 574 Ø: 45	

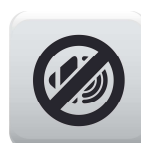

MOTORES TUBULARES

GLB



INFORMACIÓN TÉCNICA <i>TECHNICAL INFORMATION / INFORMATION TECHNIQUE</i>		DM45R 30/15
Alimentación <i>Power supply / Tension nominal-Fréquence</i>		230V / 50Hz
Potencia <i>Rated power / Puissance nominale</i>		191 W
Intensidad <i>Rated current / Courant nominal</i>		0.83 A
Par motor <i>Rated torque / Couple nominal</i>		30 Nm
Revoluciones <i>Rated speed / Vitesse nominale</i>		15 rpm
Número máximo de vueltas de recorrido <i>Max number of turns / Nombre máximo de tours de voyage</i>		45
Tiempo de funcionamiento continuo <i>Running time / Temps de travail continu</i>		4 min.
Protección <i>Degree of protection / Degré de protection</i>		IP 44
Medidas <i>Dimensions / Dimensions</i>		L1: 625
		L2: 604
		Ø: 45

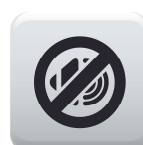

MOTORES TUBULARES

GLB



INFORMACIÓN TÉCNICA <i>TECHNICAL INFORMATION / INFORMATION TECHNIQUE</i>		DM45R 50/12
Alimentación <i>Power supply / Tension nominal-Fréquence</i>		230V / 50Hz
Potencia <i>Rated power / Puissance nominale</i>		205 W
Intensidad <i>Rated current / Courant nominal</i>		0.89 A
Par motor <i>Rated torque / Couple nominal</i>		50 Nm
Revoluciones <i>Rated speed / Vitesse nominale</i>		12 rpm
Número máximo de vueltas de recorrido <i>Max number of turns / Nombre máximo de tours de voyage</i>		45
Tiempo de funcionamiento continuo <i>Running time / Temps de travail continu</i>		4 min.
Protección <i>Degree of protection / Degré de protection</i>		IP 44
Medidas <i>Dimensions / Dimensions</i>	L1:	625
	L2:	604
	Ø:	45

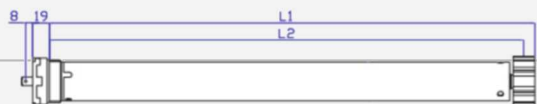

Ø 45

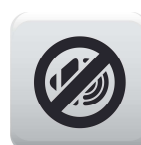

MOTORES TUBULARES

GLB



INFORMACIÓN TÉCNICA <i>TECHNICAL INFORMATION / INFORMATION TECHNIQUE</i>		DM34R 10/21
Alimentación <i>Power supply / Tension nominal-Fréquence</i>		120V / 60Hz
Potencia <i>Rated power / Puissance nominale</i>		107 W
Intensidad <i>Rated current / Courant nominal</i>		0.89 A
Par motor <i>Rated torque / Couple nominal</i>		10 Nm
Revoluciones <i>Rated speed / Vitesse nominale</i>		21 rpm
Número máximo de vueltas de recorrido <i>Max number of turns / Nombre maximum de tours de voyage</i>		36
Tiempo de funcionamiento continuo <i>Running time / Temps de travail continu</i>		4 min.
Protección <i>Degree of protection / Degré de protection</i>		IP 44
Medidas <i>Dimensions / Dimensions</i>	L1:	577
	L2:	564
	Ø:	35

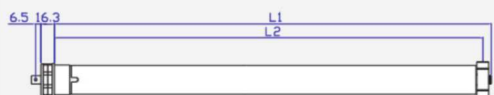

Ø 35

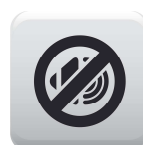

MOTORES TUBULARES

GLB



INFORMACIÓN TÉCNICA <i>TECHNICAL INFORMATION / INFORMATION TECHNIQUE</i>		DM44R 30/13
Alimentación <i>Power supply / Tension nominal-Fréquence</i>		120V / 60Hz
Potencia <i>Rated power / Puissance nominale</i>		152 W
Intensidad <i>Rated current / Courant nominal</i>		1.51 A
Par motor <i>Rated torque / Couple nominal</i>		30 Nm
Revoluciones <i>Rated speed / Vitesse nominale</i>		13 rpm
Número máximo de vueltas de recorrido <i>Max number of turns / Nombre maximum de tours de voyage</i>		45
Tiempo de funcionamiento continuo <i>Running time / Temps de travail continu</i>		4 min.
Protección <i>Degree of protection / Degré de protection</i>		IP 44
Medidas <i>Dimensions / Dimensions</i>	L1:	685
	L2:	664
	Ø:	45

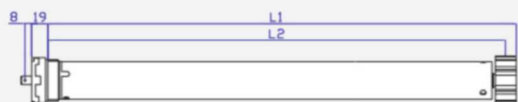

Ø 45

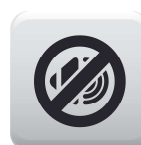

Configuración del movimiento escalonado

A Función adicional

El intervalo de configuración entre los botones debe ser igual o inferior a 6 segundos; de lo contrario, se restaurará la configuración original del sistema.

Si repite la configuración la función quedará cancelada

ok
La configuración del movimiento puntual se ha realizado correctamente

433MHz 868MHz CE
Todos los controles admiten 433 MHz y 868 MHz
Todos los controles admiten 230 V/50Hz y 120 V/60 Hz

R: Radial
Límite mecánico + receptor integrado

Por DM35R DM45RM
DM45R DM59RM
DM59R DM45RQ



Motor tubular vía radio

Especificaciones

Versión n.º: B/03

Adición de otro emisor

A Función adicional

El intervalo de configuración entre los botones debe ser igual o inferior a 6 segundos; de lo contrario, se restaurará la configuración original del sistema.

Asistencia técnica

T

- Emisor de 5 canales = Emisor de canal único x 5
Un canal del emisor puede controlar 20 receptores como máximo al mismo tiempo.
- Motor tubular vía radio
Un motor vía radio puede almacenar hasta 20 canales. Si necesita añadir más canales, deberá repetir la operación desde un segundo canal.

! Durante el proceso de configuración del emisor y del motor de tipo radial, cada vez que pulse la tecla el motor emitirá un silbido como señal (si no pulsa ninguna tecla durante 4 segundos después del silbido, el motor revertirá al estado original). Tras una configuración satisfactoria, la señal que emitirá el motor serán varios silbidos continuados. Con el receptor en el modo de función movimiento puntual, pulse la tecla UP (flecha hacia arriba) o la tecla DOWN (flecha hacia abajo) durante 2 segundos para que el motor de control del emisor funcione en movimiento puntual. Si se pulsa durante más de 2 segundos, el motor funcionará de manera continuada. El código de compatibilización del canal de control grupal no es viable. Cuando los canales de grupo funcionan al mismo tiempo, el emisor no se puede programar. Mientras está en modo movimiento puntual, todavía son posibles la adición y la cancelación del emisor.

Rango de control

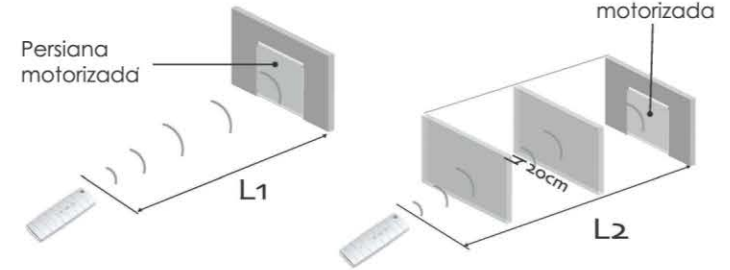

	L1 Open	L2 Partition	Emission frequency
230V/50Hz	200m	35m	433.92MHz
120V/60Hz	200m	35m	

Cancelación del emisor

A Función adicional

El intervalo de configuración entre los botones debe ser igual o inferior a 6 segundos; de lo contrario, se restaurará la configuración original del sistema.

La cancelación del emisor consiste en borrar todos los datos de la memoria del receptor almacenados en el motor

Emisor y motores compatibles

T Asistencia técnica

! DC48 DC49 DC44 DC61 DC115
Pulsar el botón SUBIDA y el botón PARADA es equivalente al botón P2

Emisor de un canal DC90	Emisor de 5 canales DC92	Emisor de 15 canales DC94	Emisor portátil en miniatura DC14	Emisor portátil en miniatura DC44	Emisor portátil en miniatura DC61	Emisor portátil en miniatura DC115	DM35R R: vía radio Límite mecánico + receptor integrado
Emisor con temporizador un canal DC112	Emisor con temporizador 15 canales DC137	Emisor con temporizador 15 canales DC170	Emisor con temporizador un canal DC111	Emisor portátil un canal montado en pared DC48	Emisor portátil doble montado en pared DC49	Sensor de viento y sol DC83	DM45R R: vía radio Límite mecánico + receptor integrado
							DM45RQ RQ: vía radio con silenciador Límite mecánico + receptor integrado + dispositivo silenciador
							DM45RM RM: vía radio y manual Límite mecánico + receptor integrado + manual
							DM59R R: vía radio Límite mecánico + receptor integrado
							DM59RM RM: vía radio y manual Límite mecánico + receptor integrado + manual

Problemas frecuentes y soluciones

! Atención

	Problema	Causas del problema	Resolución del problema
1	Al encenderlo, el adaptador solo funciona en una dirección	El interruptor del límite interior del motor no se abre	Desplazar la corona circularmente en la dirección opuesta a la del adaptador de la unidad para que funcione.
2	Al conectar la alimentación, el motor se inicia lentamente o no funciona	a. La tensión eléctrica es baja b. Error de cableado c. Sobrecarga d. Instalación incorrecta	a. Ajustar la potencia a los datos nominales b. Comprobar el circuito y corregir las conexiones erróneas c. Par nominal asociado con la instalación de la carga d. Reinstalar el motor
3	El motor se detiene bruscamente tras funcionar de forma normal	El motor funciona un periodo superior al tiempo nominal (4 minutos)	El motor se volverá a encender automáticamente tras un periodo de reposo de 20 minutos.
4	Sonido anormal durante el funcionamiento de la persiana	El tubo exterior es demasiado largo, y la conexión de la persiana con ambos soportes está demasiado ajustada	Acortar el tubo para evitar un ajuste demasiado apretado

Instrucciones del motor

T Asistencia técnica

Orificio de inserción de la manivela, Orificio de límite blanco, Dirección del límite de ajuste, Orificio de límite rojo, Regulador de límite especial, Amarre de la manivela

INTERRUPTOR DE LÍMITE, CAPACITADOR, MOTOR, FRENO, ENGRANAJE

Accesorios de la manivela

Manivela DS38, Manivela DS39, Manivela externa DS21

1 Instalación de la corona

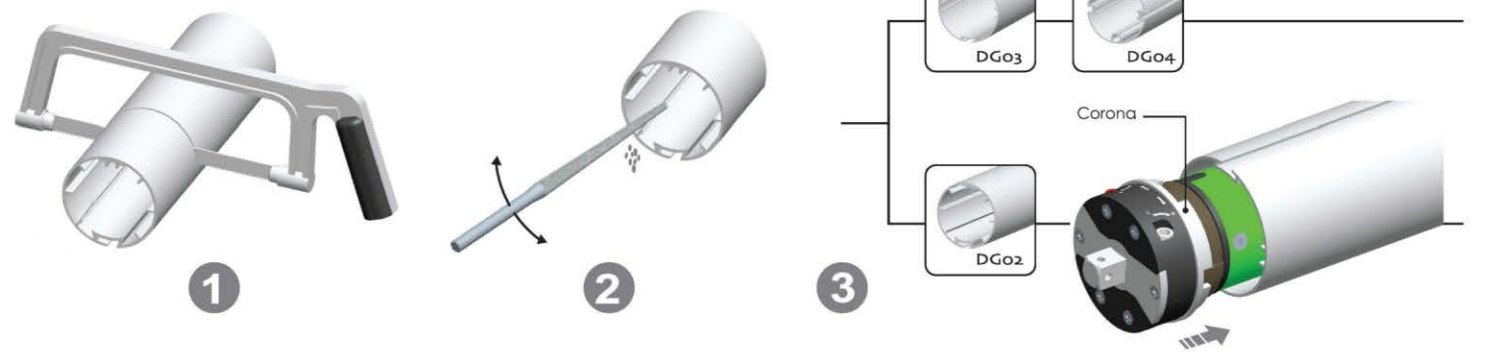

2 Instalación del adaptador de la unidad

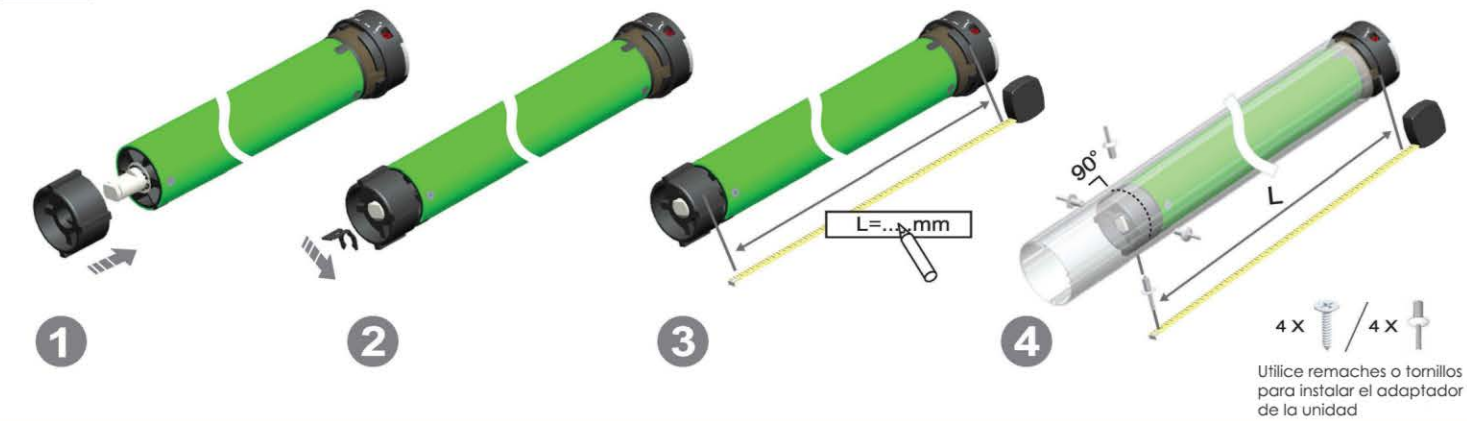

3 Instalación de los soportes

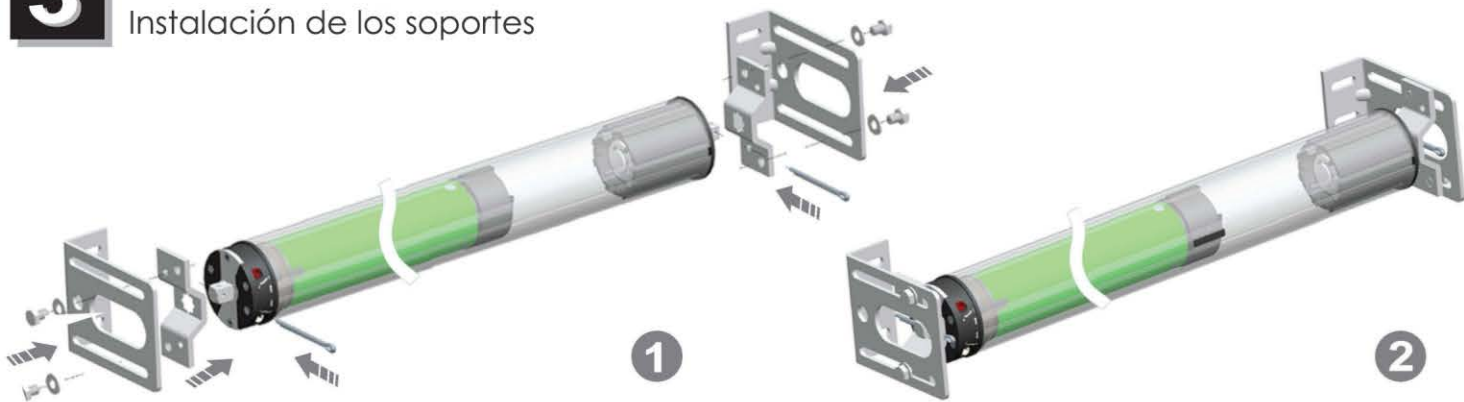

4 Instalación del circuito

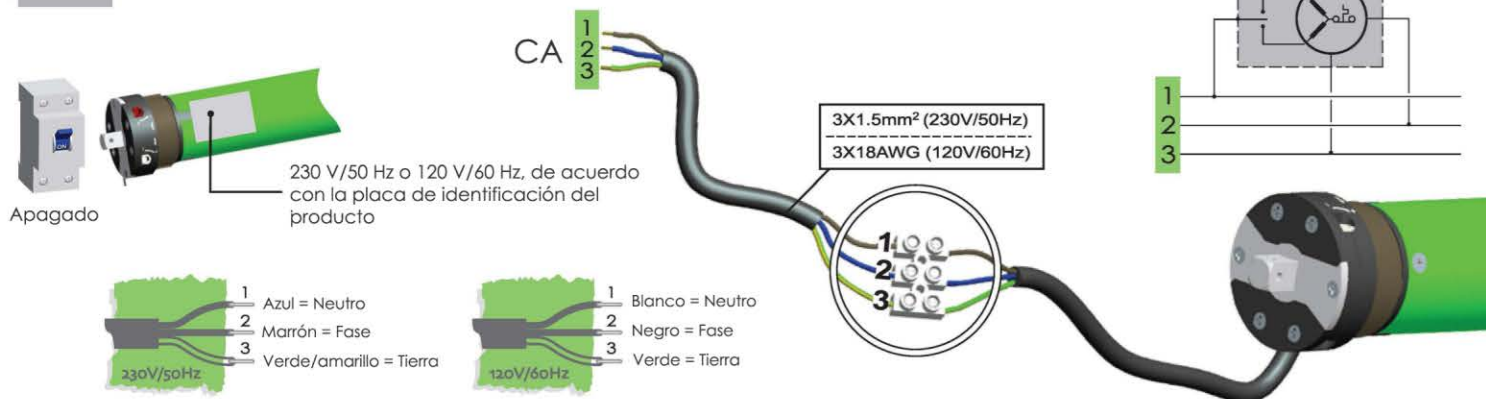

5 Programación del primer transmisor Primer método

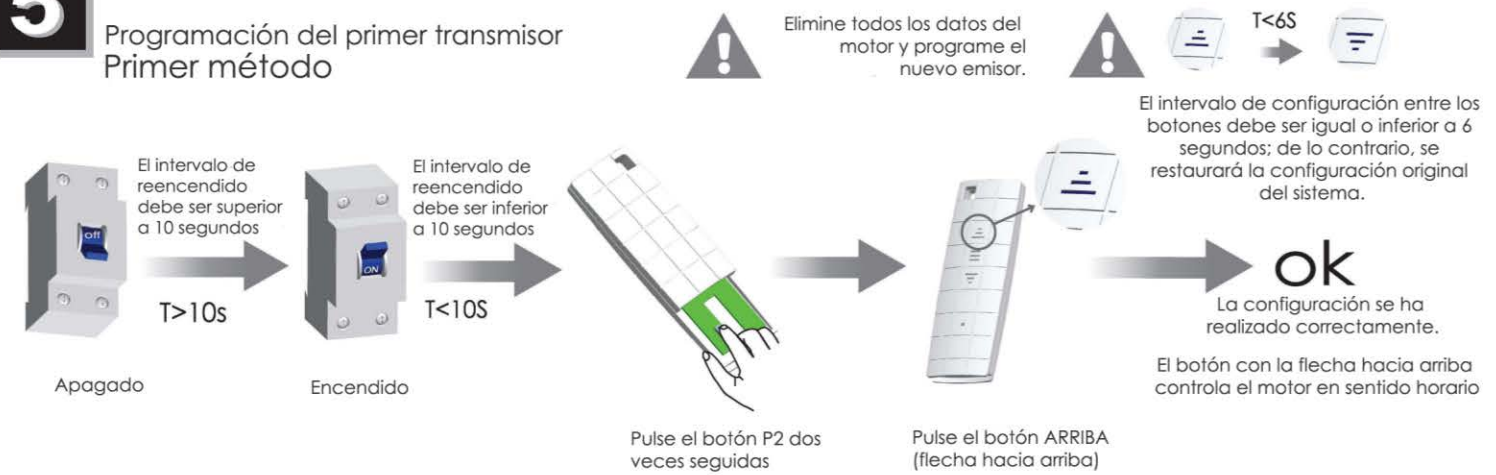

Segundo método

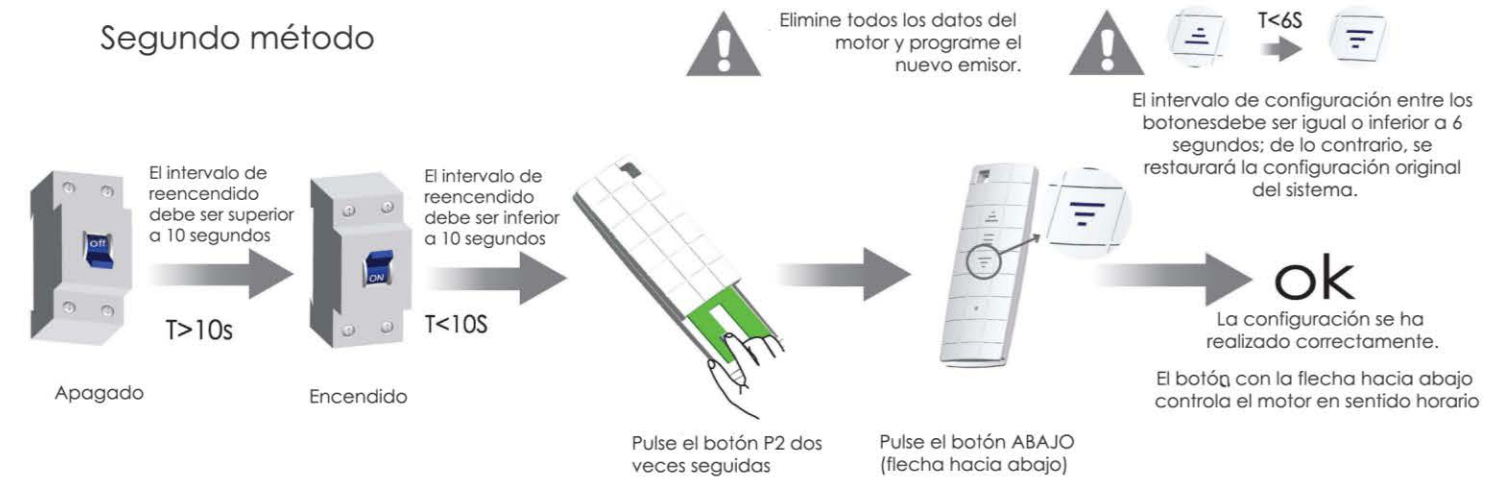

6 Configuración del fin de carrera superior

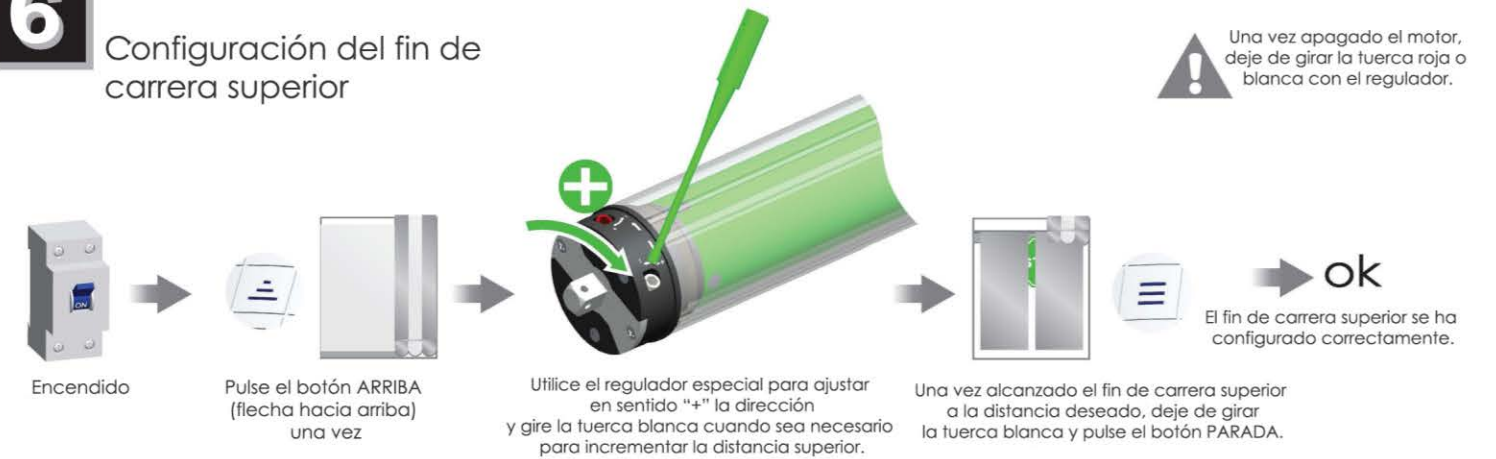

7 Configuración del fin de carrera inferior

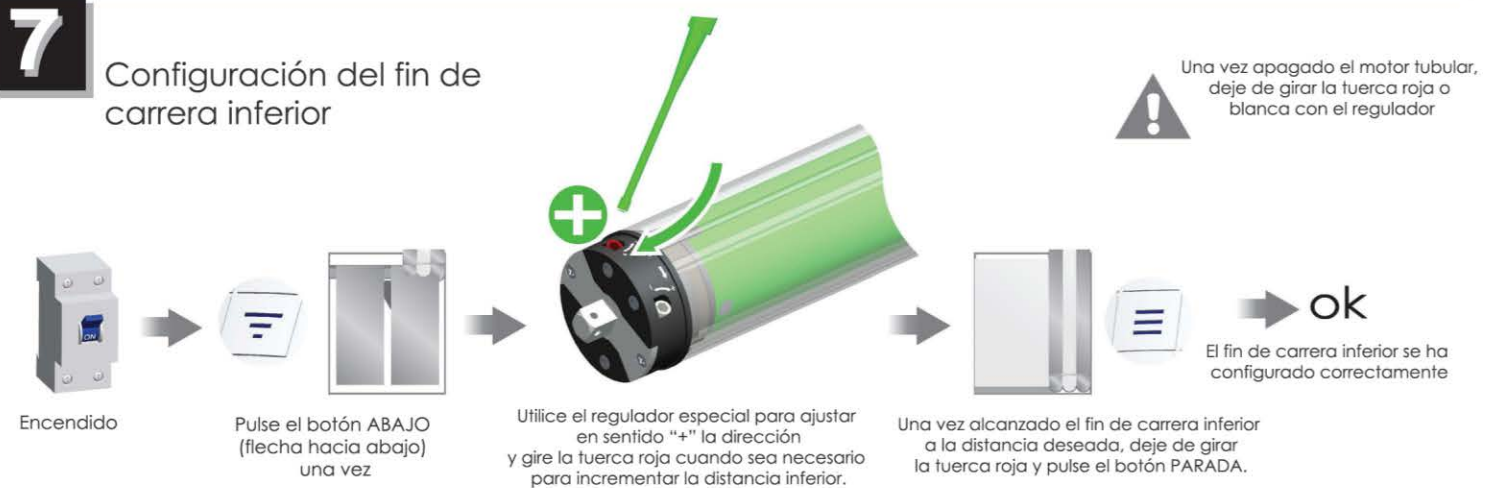



Dot-move setting

Additional Function

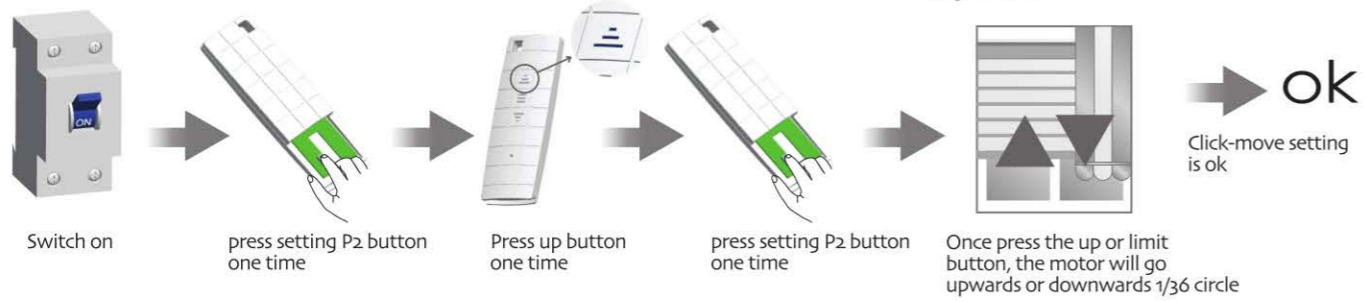

The interval of each button must within 6 seconds of re-setting, otherwise the system will restore the original state.

Repeat setting, function is cancelled



All controls support 433MHz & 868MHz
All controls support 230V/50Hz & 120V/60Hz

R: Radio
Mechanic Limit + Built-in Receiver

By DM35R DM45RM
DM45R DM59RM
DM59R DM45RQ



Radio Tubular Motor Specification



Add Emitter

Additional Function

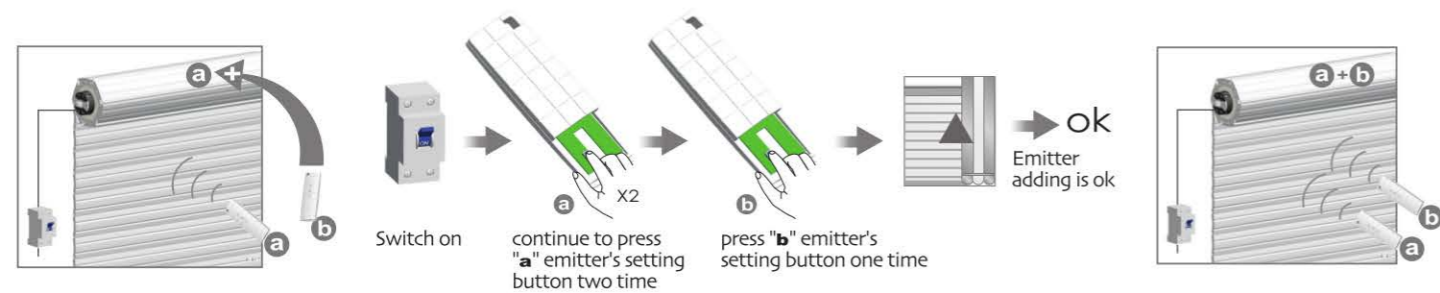

The interval of each button must within 6 seconds of re-setting, otherwise the system will restore the original state.



Technical Support

- 5-channel emitter = single channel emitter × 5
One channel of emitter can control 20 receivers at most at the same time.
- Radio Tubular Motor
One R motor maximum can store 20 channels, over 20 channels, if still need add new channels, it will be repeating covered in turn from second channel.

Control Range

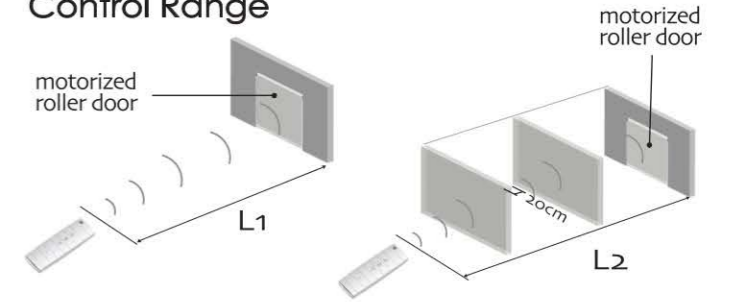

	L1 Open	L2 Partition	Emission frequency
230V/50Hz	200m	35m	433.92MHz
120V/60Hz	200m	35m	

In the process of set up emitter and R type motor, every time press the key, motor will whistle one time as the signal (not press any key within 4 seconds after the whistle, the motor will turn to the original state). After the success of the set up, motor continuous whistle many times as signal.
Receiver in the mode of dot function, press up key and down key within 2 seconds, emitter control motor working in dot function; if continuous press more than 2 seconds motor will last working.
Group control channel match code is unworkable, when group channel work together, the emitter can't be programmed, while function of dot-move, emitter-add and emitter-cancel still means.



Cancel Emitter

Additional Function

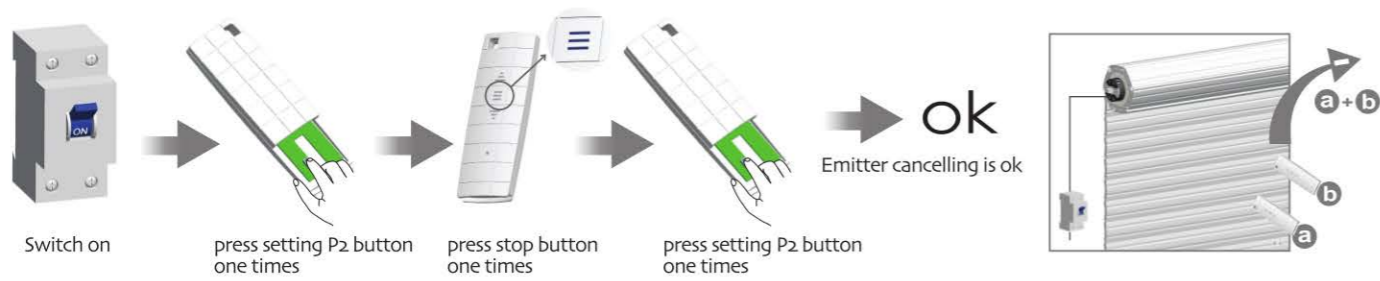

The interval of each button must within 6 seconds of re-setting, otherwise the system will restore the original state.

Canceling emitter is that remove all the memory of receiver stored in radio motor



Matchable emitter and motors

Technical Support

DC48 DC49 DC44 DC61 DC115
Pressing up button and stop button equals P2 button

single channel emitter DC90	5-channel emitter DC92	15-channel emitter DC94	miniaturised portable emitter DC14	miniaturised portable emitter DC44	miniaturised portable emitter DC61	miniaturised portable emitter DC115	DM35R R: Radio Mechanic Limit + Built-in Receiver
single channel timer emitter DC112	15-channel timer emitter DC137	15-channel timer emitter DC170	single channel timer emitter DC111	Portable single wall-mounted emitter DC48	Portable double wall-mounted emitter DC49	Wind-sun sensor DC83	DM45R R: Radio Mechanic Limit + Built-in Receiver
							DM45RQ RQ: Quiet Radio Mechanic Limit+ Built-in Receiver + Quiet Device
							DM45RM RM: Radio With Manual Mechanic Limit + Built-in Receiver + Manual
							DM59R R: Radio Mechanic Limit + Built-in Receiver
							DM59RM RM: Radio With Manual Mechanic Limit + Built-in Receiver + Manual



Common failures and solutions

Attention

	Fail-phenomena	Failure causes	solutions failure recovery
1	Switch on, the drive adapter runs in one-way operation	Inside limit switch of motor doesn't open	Crown running one circle in the opposite direction of the drive adapter, then it works
2	motor starts slowly or not work after connect power	a. Power voltage is low b. Wiring error c. Overload d. Improper installation	a. Adjust power to rated data b. Check circuit and correct wiring connecting c. Rated torque associated with the installation of the load d. Re-install the motor
3	Motor stops suddenly after running	The motor works continuously for over the rated time - 4 minutes.	Motor will automatically resume work after 20 minutes cooling
4	Abnormal sound during roller blinds in operation	Outer tube is too long, led the rolling shutter connects with both sides of bracket too tightly	if idler is active, propering make the tube shorter to avoid too tight status.



Instruction Of The Motor

Technical Support

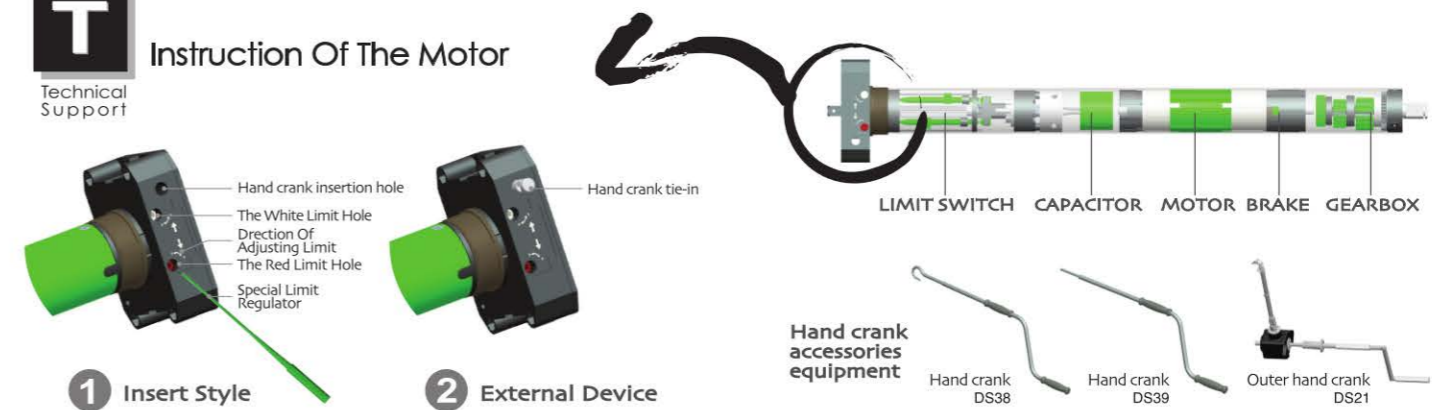

1 Crown installation

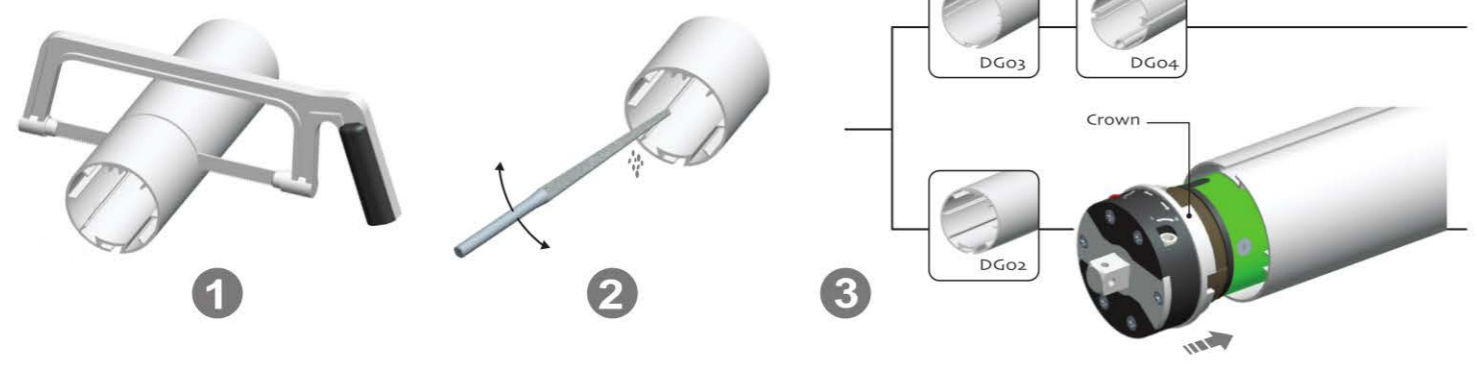

2 Drive adapter installation

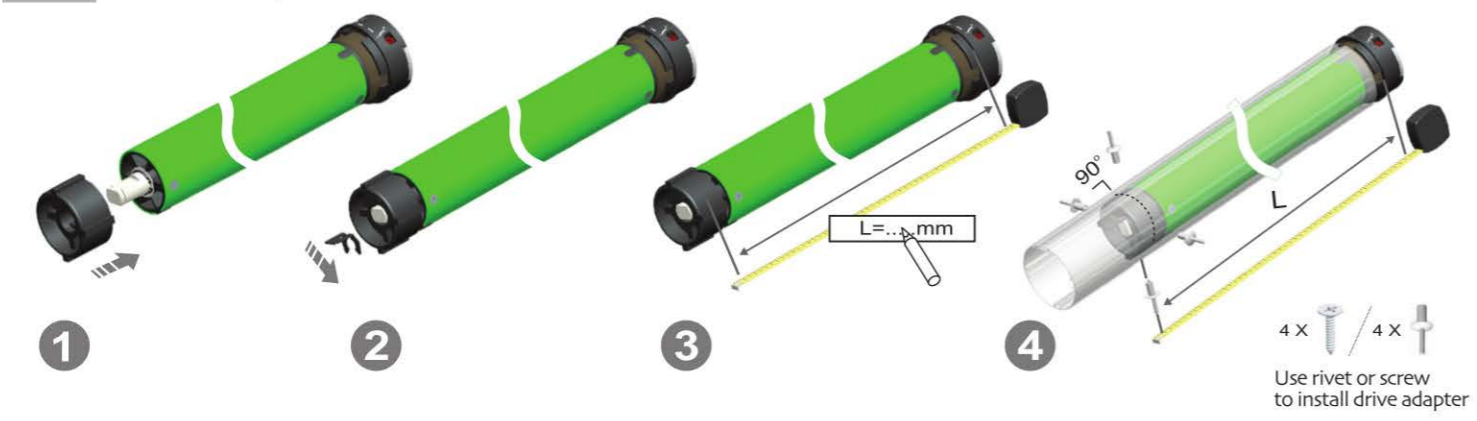

3 Bracket installation

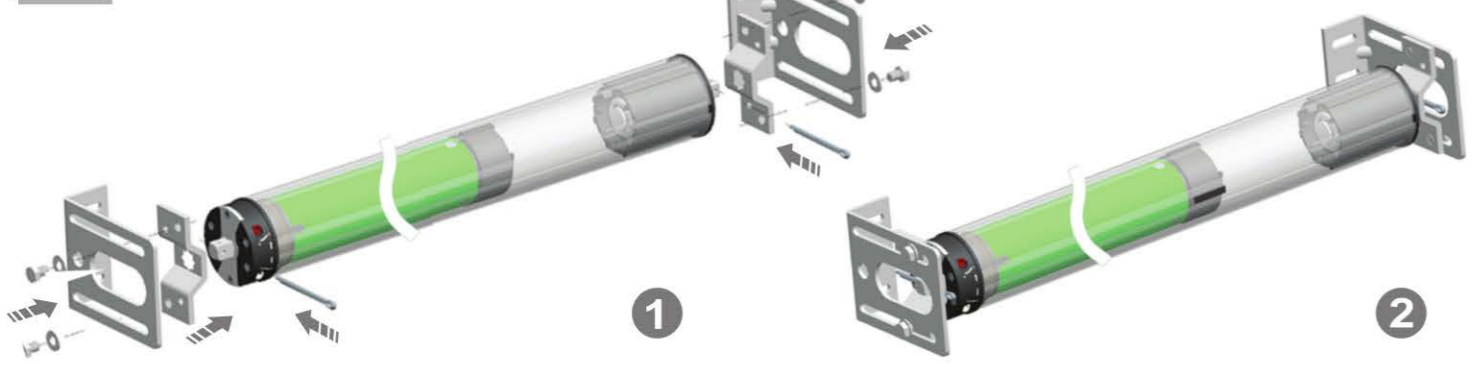

4 Circuit installation

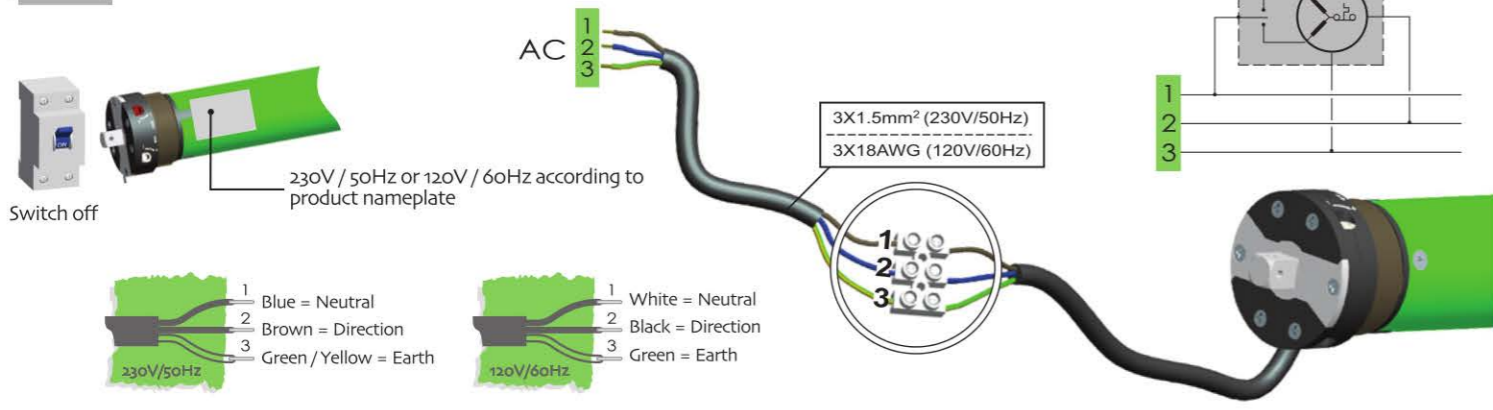

5 Programming the first transmitter The first method

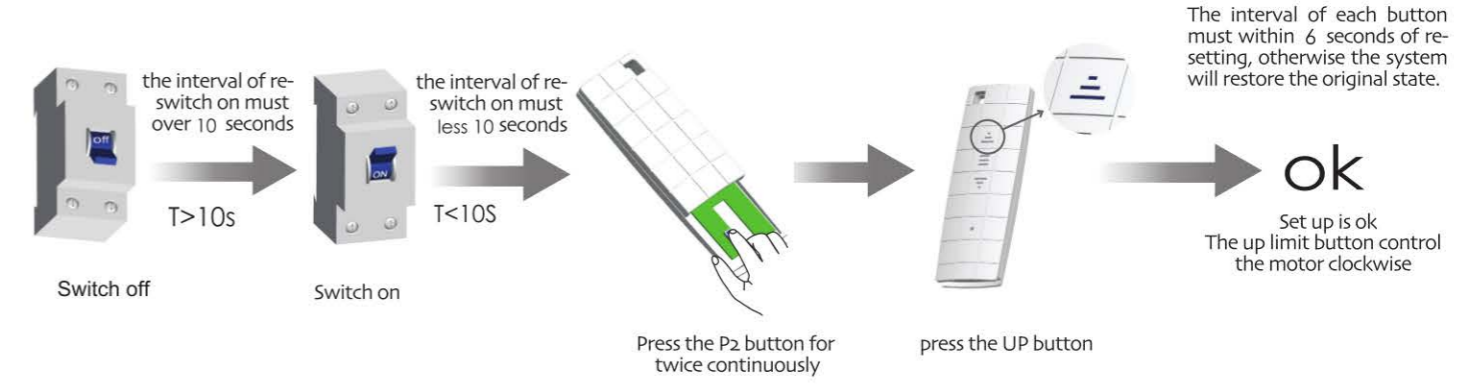

The second method

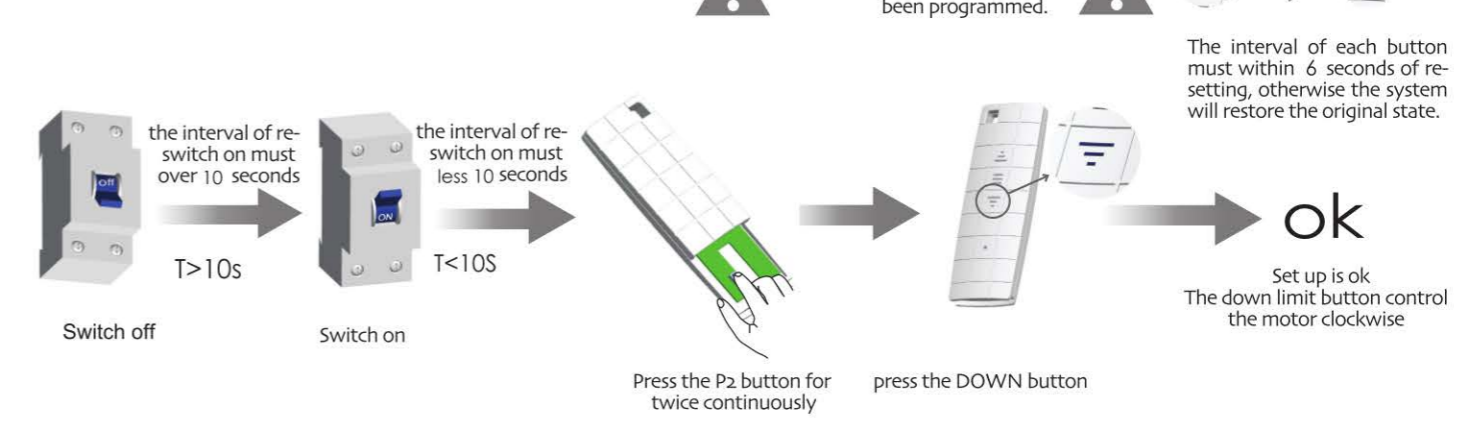

6 Up limit setting

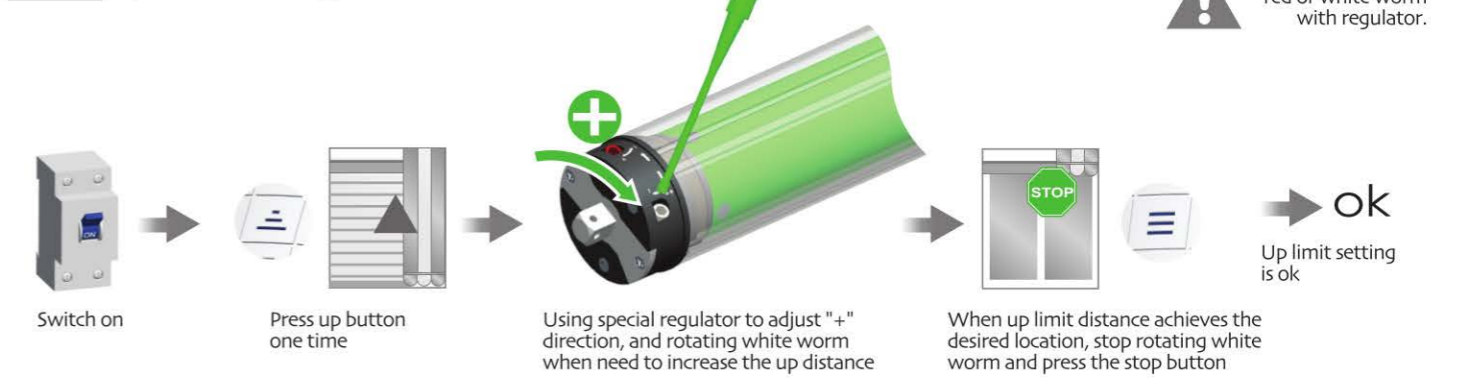

7 Down limit setting



A Configuration du mouvement échelonné

Fonction additionnelle

! L'intervalle de configuration entre les touches doit être égal ou inférieur à 6 s econdes, autrement la configuration d'origine du système sera restaurée.

! Si vous refaites la configuration, la fonction sera annulée

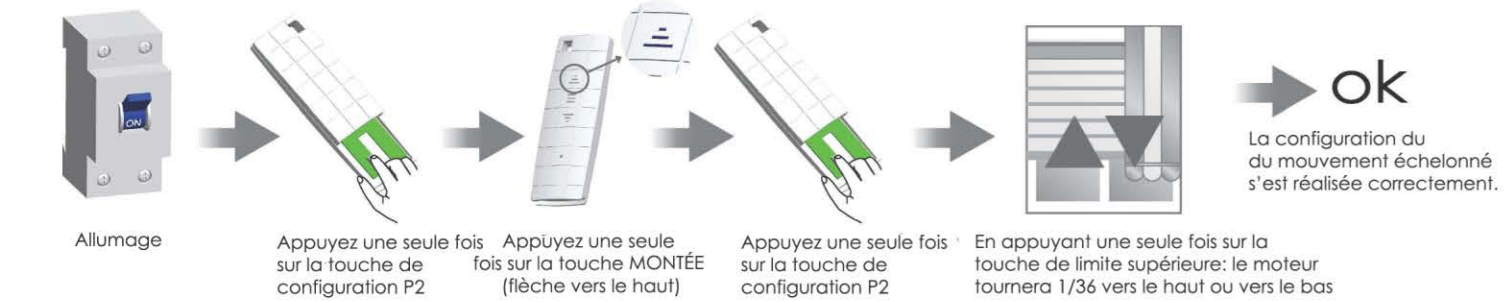

433MHz 868MHz CE
Tous les contrôles admettent 433 MHz y 868 MHz
Tous les contrôles admettent 230 V/50Hz y 120 V/60 Hz



R: Via radio
Limite mécanique + récepteur intégré

Par DM35R DM45RM
DM45R DM59RM
DM59R DM45RQ



Version n: B/03

Moteur tubulaire via radio

Spécifications

A Ajout d'un autre émetteur

Fonction additionnelle

! L'intervalle de configuration entre les touches doit être égal ou inférieur à 6 s econdes, autrement la configuration d'origine du système sera restaurée.

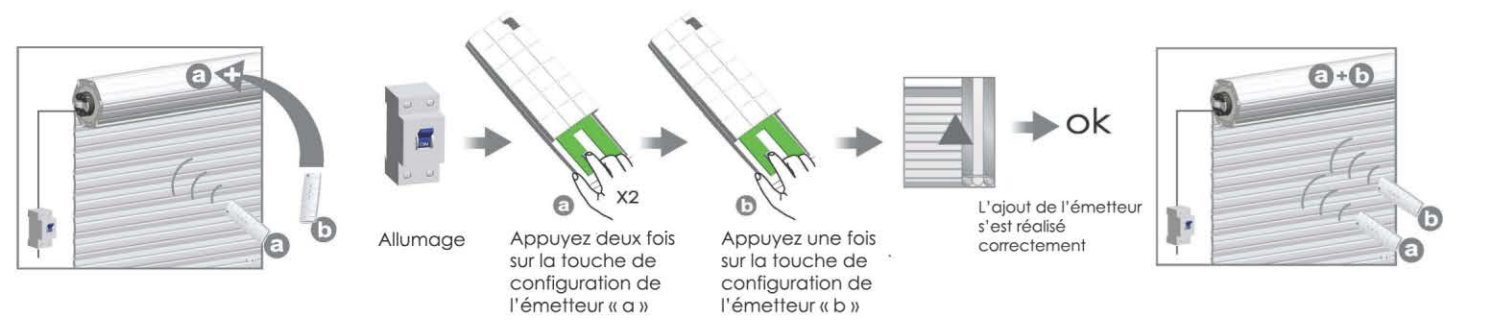

T Assistance technique

1. Emetteur de 5 canaux = Emetteur d'un canal x 5
Un canal de l'émetteur peut contrôler un maximum de 20 récepteurs en même temps
2. Moteur tubulaire via radio
Un moteur tubulaire radial peut emmagasiner un maximum de 20 canaux. Si vous souhaitez ajouter plus de canaux, vous devrez répéter l'opération depuis un deuxième canal.

! Pendant le processus de configuration de l'émetteur et du moteur de type radial, chaque fois que vous appuyez sur la touche, le moteur émettra un sifflement en tant que signal (si vous n'appuyez sur aucune touche pendant les 4 secondes après le sifflement, le moteur redeviendra à l'état original). Si la configuration s'est réalisée correctement, le moteur émettra en tant que signal plusieurs sifflements de façon continue. Avec le récepteur en mode de fonctionnement ponctuel, appuyez sur la touche MONTÉE (flèche vers le haut) ou la touche DESCENTE (flèche vers le bas) pendant 2 secondes afin que le moteur de contrôle de l'émetteur fonctionne en mouvement ponctuel. Si vous appuyez la touche pendant plus de 2 secondes, le moteur fonctionnera de façon continue. Le code de compatibilité du canal de contrôle global n'est pas viable. Quand les canaux de groupe fonctionnent en même temps, l'émetteur ne peut pas être programmé. S'il est en mode de mouvement échelonné, il est encore possible d'ajouter ou d'annuler l'émetteur.

Rang de contrôle

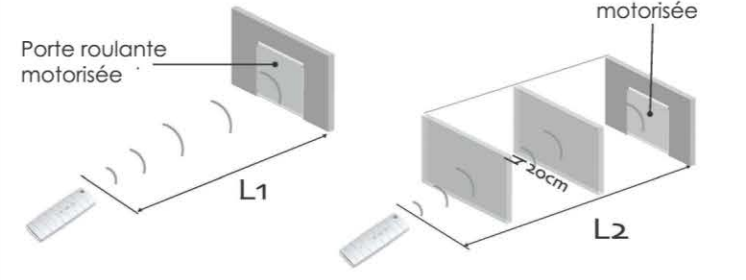

	L1 Ouvert	L2 Partitions	Fréquence d'émission
230V/50Hz	200m	35m	433.92MHz
120V/60Hz	200m	35m	

A Annulation de l'émetteur

Fonction additionnelle

! L'intervalle de configuration entre les touches doit être égal ou inférieur à 6 s econdes, autrement la configuration d'origine du système sera restaurée.

! L'annulation de l'émetteur consiste à effacer toutes les données de la mémoire du récepteur emmagasinées dans le moteur

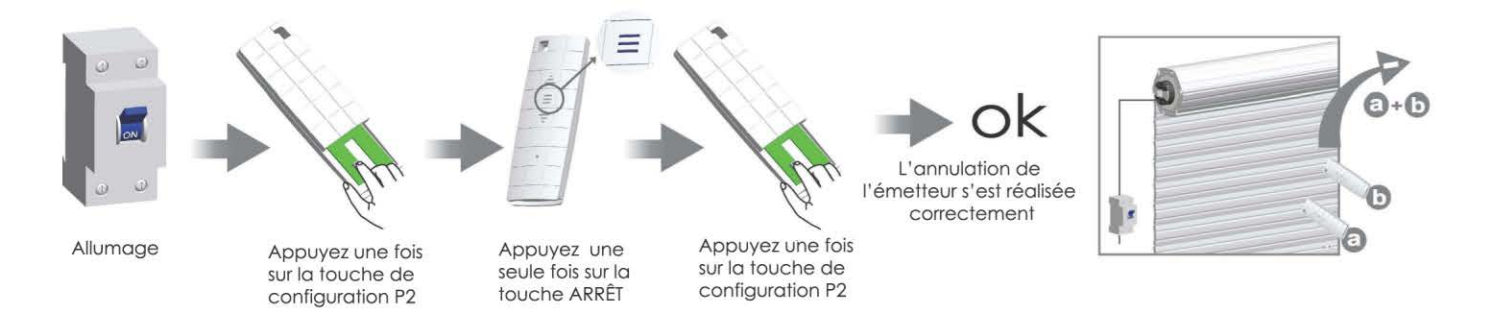

T Emetteur et moteurs compatibles

Asistencia técnica

! DC48 DC49 DC44 DC61 DC115 Appuyez sur la touche MONTÉE (flèche vers le haut) et sur la touche ARRÊT (flèche vers le bas) à appuyer sur la touche P2

<ul style="list-style-type: none"> Emetteur d'un canal DC90 Emetteur de 5 canaux DC92 Emetteur de 15 canaux DC94 Emetteur portable en miniature DC14 Emetteur portable en miniature DC44 Emetteur portable en miniature DC61 Emetteur portable en miniature DC115 Emetteur avec temporisateur un canal DC112 Emetteur avec temporisateur de 15 canaux DC137 Emetteur avec temporisateur de 15 canaux DC170 Emetteur avec temporisateur un canal DC111 Emetteur portable unique posé sur mur DC48 Emetteur portable double posé sur mur DC49 Capteur de vent et soleil DC83 	<ul style="list-style-type: none"> DM35R R: Via radiol Limite mécanique + récepteur intégré DM45R R: Via radiol Limite mécanique + récepteur intégré DM45RQ RQ: Via radio silencieux Limite mécanique + récepteur intégré + dispositif silencieux DM45RM RM: Via radio manuel Limite mécanique + récepteur intégré + manuel DM59R R: Via radiol Limite mécanique + récepteur intégré DM59RM RM: Via radio manuel Limite mécanique + récepteur intégré + manuel
----------------------------------------------------------------------------------------------------------------------------------------------------------------------------------------------------------------------------------------------------------------------------------------------------------------------------------------------------------------------------------------------------------------------------------------------------------------------------------------------------------------------------------------------------------------------------------------------------------------------------------------------------------------------------------------------------------------	----------------------------------------------------------------------------------------------------------------------------------------------------------------------------------------------------------------------------------------------------------------------------------------------------------------------------------------------------------------------------------------------------------------------------------------------------------------------------------------------------------------------------------------------------

! Problèmes fréquents et solutions

Attention

	Problèmes	Causes du problème	Résolution du problème
1	En l'allumant, l'adaptateur de l'unité fonctionne seulement dans un sens	L'interrupteur de limite intérieure du moteur ne s'ouvre pas	Déplacez la couronne de façon circulaire dans le sens opposé à celui de l'adaptateur de l'unité afin de le mettre en marche
2	En branchant l'alimentation, le moteur démarre très lentement ou ne marche pas	a. La tension électrique est faible b. Erreur du câblage c. Surcharge d. Installation incorrecte	a. Ajustez la puissance des données nominales b. Vérifiez le circuit et corrigez les connexions erronées c. Couple nominal associé avec l'installation de la charge d. Réinstallez le moteur
3	Le moteur s'arrête brusquement après une période de fonctionnement normal	Le moteur s'arrête brusquement après une période de fonctionnement normal	Le moteur se rallumera automatiquement après un temps de repos de 20 minutes
4	Bruit anormal pendant le fonctionnement de la persienne	Le tube extérieur est trop long, ce qui provoque que la connexion de la persienne avec les deux supports soit trop serrée	Raccourcissez le tube afin d'éviter un ajustement trop serré.

T Mode d'emploi du moteur

Assistance technique

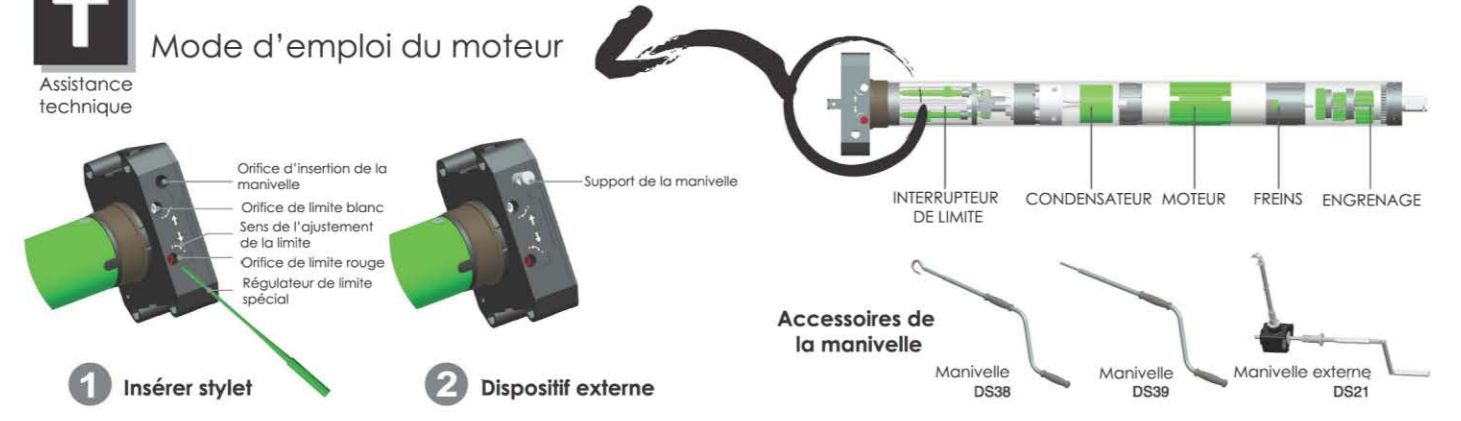

1 Installation de la couronne

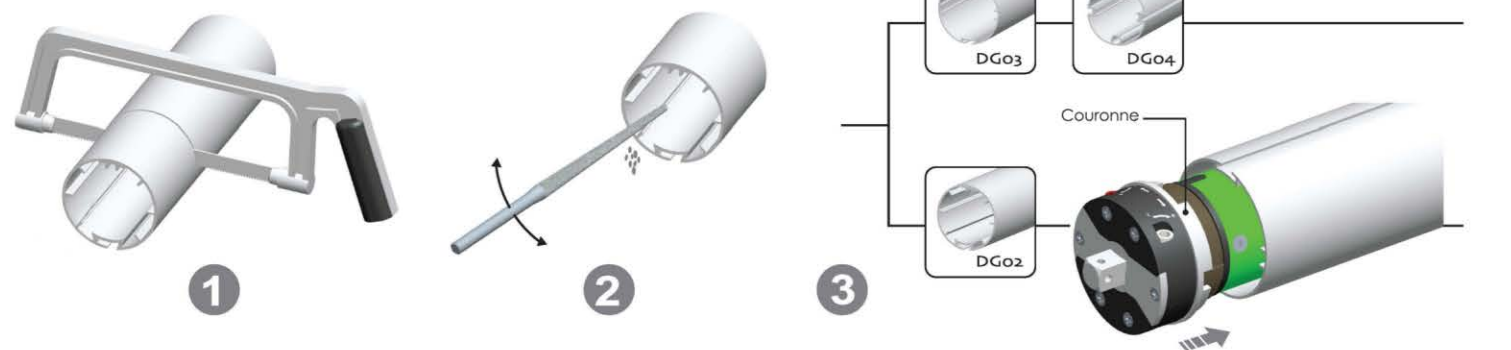

2 Installation de l'adaptateur de l'unité

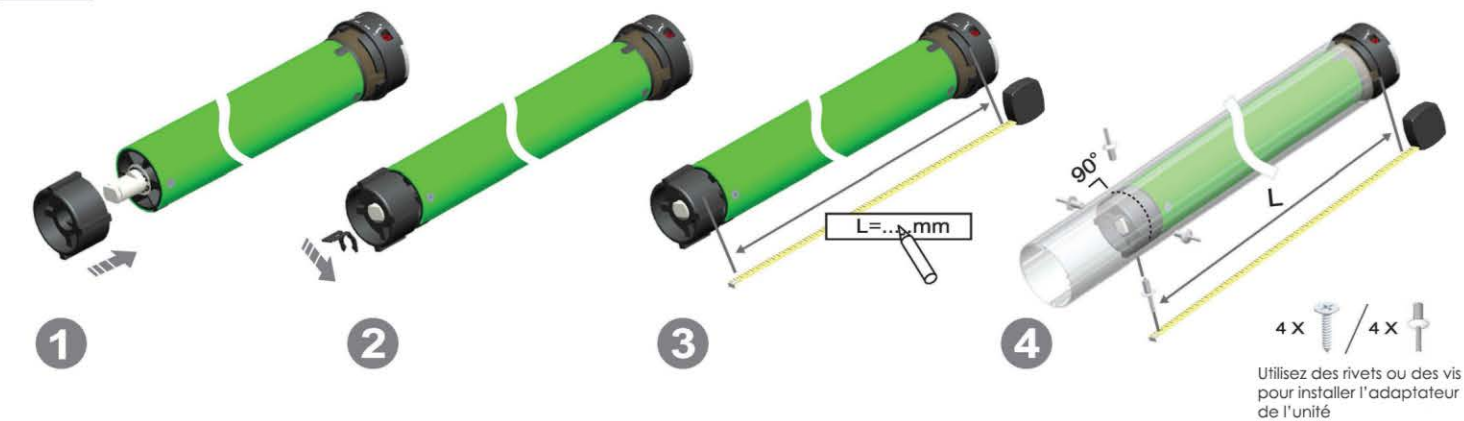

3 Installation des supports

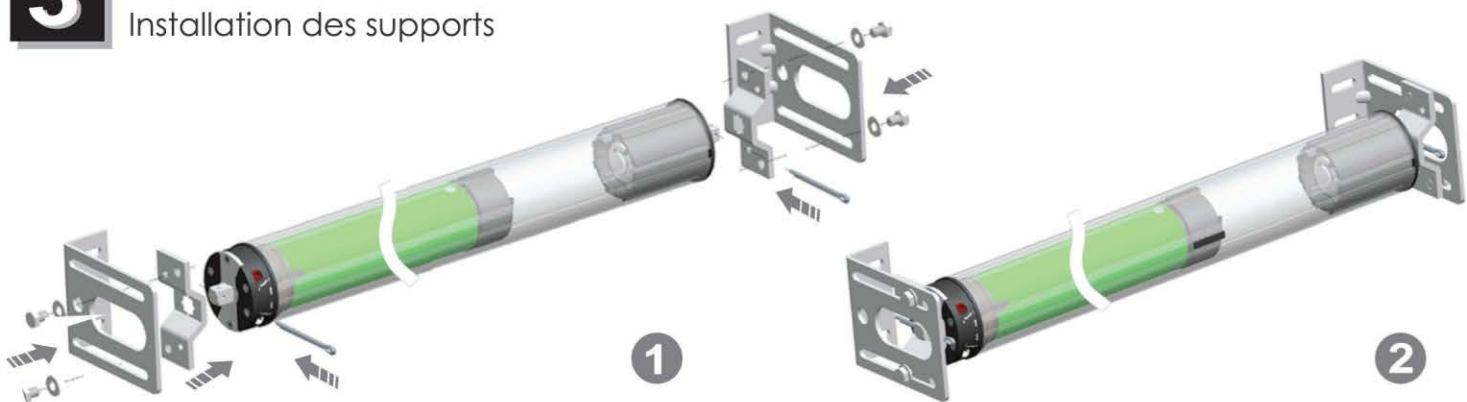

4 Installation du circuit

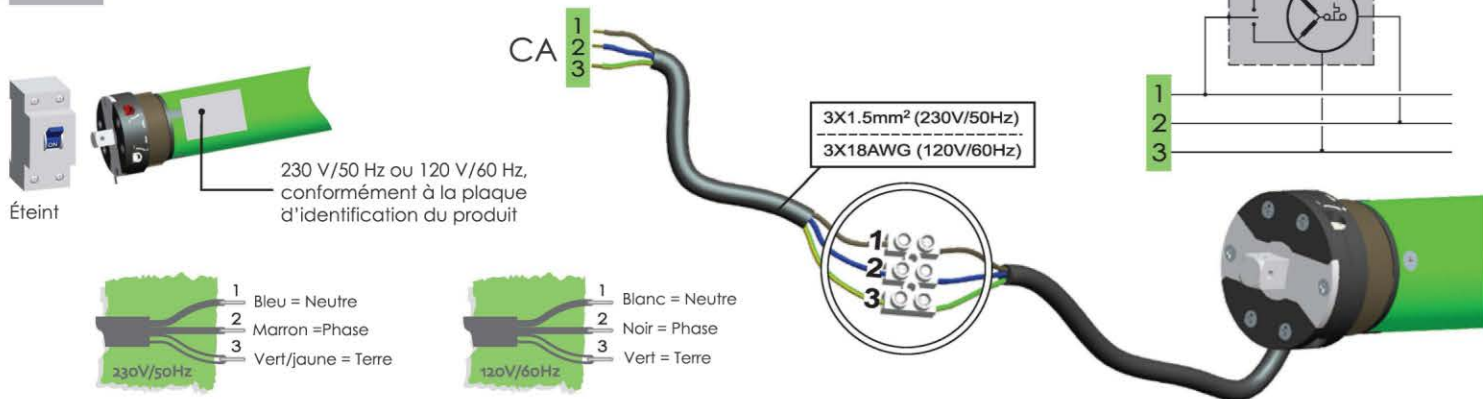

5 Programmation du premier émetteur Première méthode

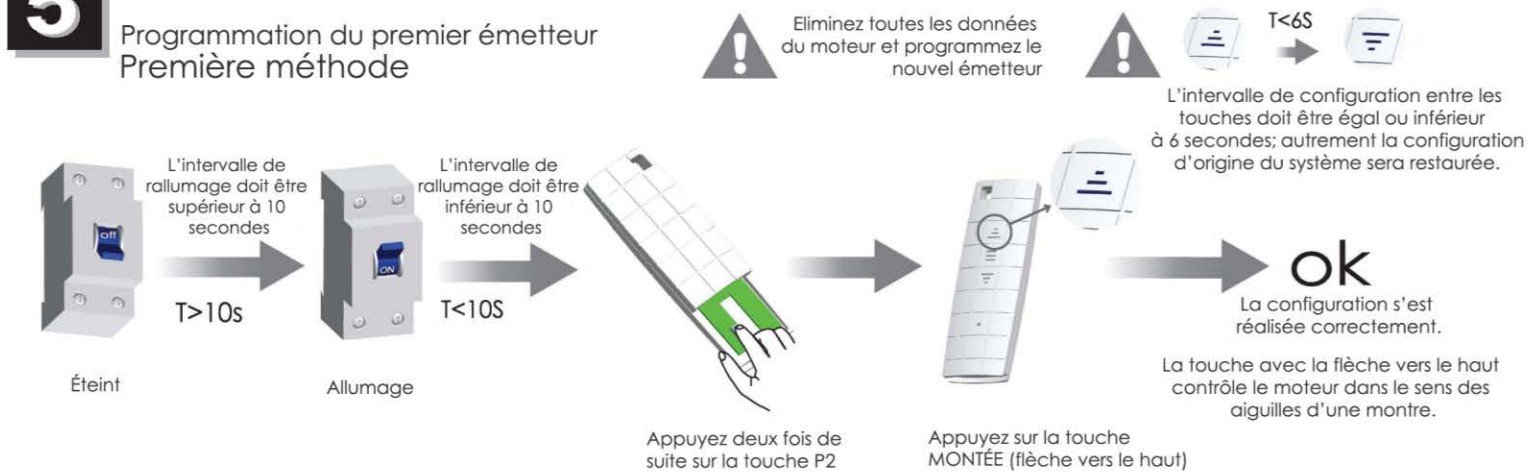

Deuxième méthode

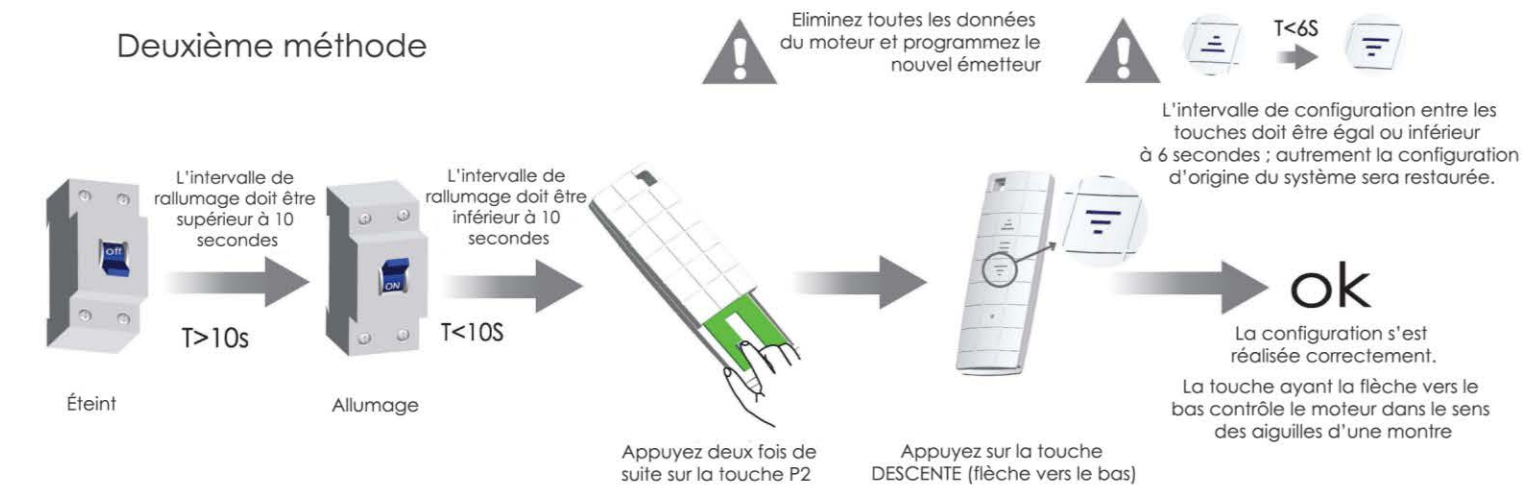

6 Configuration de la fin de course supérieure

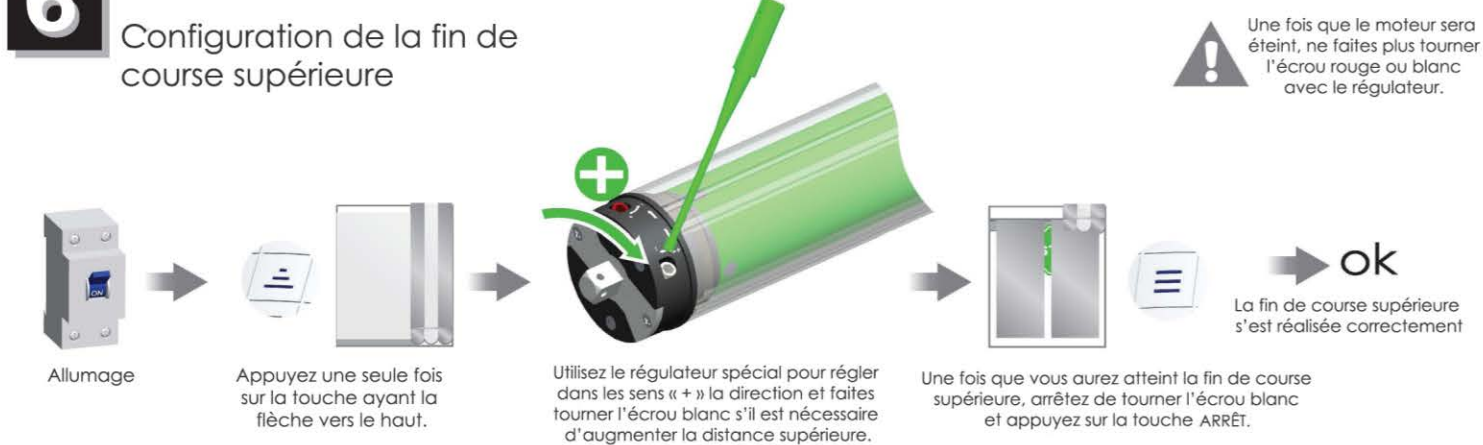

7 Configuration de la fin de course inférieure

